



Wireless Headset EHS Guide



Designer and Manufacturer of
**Professional Headsets for Contact Centres
& Unified Communications**



Wireless Headset EHS User Guide

Introduction

Electronic Hook Switch(EHS) provides a solution that enables remote operation of answer/end functions for wireless headsets with various phones, thus eliminating the need for a mechanical handset lifter.

Mobility

With an EHS solution you can roam within your premises and still do business on the spot. Wireless headsets with EHS functionality boost productivity as they provide the user with the ability to answer and end a call, while away from their desk.

EHS support the following phone system manufacturers:

Wireless Headset EHS Compatibility Table

2023

Phone Model	EHS Adapter	JPL Part No
AASTRA / MITEL 5370, 5370ip, 5380, 5380ip, 6739i, 6771, 6773, 6773ip, 6775, 6775ip, 7434ip, 7444ip *6735i, *6737i, *6753i, *6755i, *6757i,	DS-DHSG Cable *Needs Aastra(Mitel) DHSG Kit	EHS-3
AASTRA / MITEL 6920, 6940	USB A-type	EHS-20
ALCATEL-LUCENT 4028 EE, 4029, 4038 EE, 4068 EE,	MSH Adapter	EHS-7
ALCATEL-LUCENT 8028s, 8058s, 8068s, 8078s	SATA Type Connector Adapter Cord	EHS-18
ALCATEL-LUCENT 8019s, 8029s, 8039s	MSH Adapter and Extension Cable Kit	EHS-26
ALCATEL-LUCENT 20H, 30H, 40H	USB A-type	EHS-32
Allworx IP 9112, 9204, 9212, 9224, Verge 9312/9308/9304/9318Ex	Adapter	EHS-21
AVAYA 1408, 1416, 1608, 1616, 2410, 5410, 6224D+M, 6416D+M, 9404, 9408, 9504, 9508, 9608, 9610, 9611, 9620, 9621, 9630, 9640, 9641, 9650, 9670, J179, J100	AEI-II(Avaya) Adapter Kit	EHS-4
AVAYA 4610, 4620, 4621, 4622, 4625, 4630, 5420, 5610, 5620, 5621, 5625, 4610SW, 4620SW, 4621SW, 4622SW, 4625SW, 4630SW	Avaya compatible EHS Cable	EHS-15
AVAYA 1120E, 1140E, 1150E, 1165E	USB A-type	EHS-25
CISCO 6821, 6841, 6851, 6861, 6871, 6945, 7821, 7841, 7861, 7942G , 7945G, 7962G, 7965G, 7975G, 8811, 8841, 8845, 8851, 8861, 8865	HHC Adapter	EHS-2
CISCO 8941, 8945, 8945G	Adapter	EHS-16
CISCO (with USB Port) 8851, 8961, 9951, 9971	USB A-type EHS Adapter	EHS-12
ERICSSON-LG LIP-9010, LIP-9020, LIP-9050, iPECS 1030i	LG EHS Adapter Needs Ericsson-LG EHS Kit	EHS-11
ERICSSON-LG LIP-9071	USB A-type EHS Adapter	EHS-22
ERICSSON-LG LIP-9010, LIP-9020, LIP-9050, iPECS 1030i	LG EHS Adapter with JTAG	EHS-19
GRANDSTREAM GXP1610/1615, GXP1620/1625, GXP1628/1630, GXP1760/W, GXP1780/1782, GXP2124, GXP2130, GXP2135, GXP2140, GXP2160, GXP2170, GXP2200,	Grandstream Adapter Kit	EHS-13

Wireless Headset EHS Compatibility Table

2023

Phone Model	EHS Adapter	JPL Part No
GRANDSTREAM GXP3240, GXV3275	Grandstream Adapter Kit	EHS-29
HTEK UC804, / 804T / 804G / 806 / 806T / 806G / 840 / 842 / 860 / 862 / 913 / 923 / 924 / 926	EHS Adapter	EHS-17
NEC DT330 Series, DT430 Series, DT730 Series, DT830 Series, DT830G Series	EHS Adapter	EHS-27
PANASONIC DT543, DT546, NT553, NT556, HDV230,	Panasonic compatible EHS Cable	EHS-1
PANASONIC NT543	Panasonic compatible EHS Cable	EHS-14
POLYCOM IP320, IP321, IP330, IP331, IP335, IP435, IP450, IP550, IP560, IP650, IP670, VVX101 / 150 / 201 / 250 / 300 / 301 / 310 / 311 / 350 / VVX400 / 401 / 410 / 411 / 450 / 500 / 600 / 1500	Polycom compatible EHS Cable	EHS-5
SHORETEL IP212K, IP230, IP230G, IP265, IP560, IP560G, IP565, IP565G	Adapter Kit	EHS-31
SIEMENS/UNIFY OpenStage 30/40/60/80, OptiPoint Basic/Std/Adv/Eco 410/420/500/600	DS-DHSG Cable	EHS-3
SNOM *300, *320, *360, *370, *820, *821, *870	DS-Gender *Needs SNOM EHS Adapter	EHS-6
SNOM 720, 760	USB A-type EHS Adapter	EHS-23
SNOM 300, 320, 360, 370, 820, 821, 870	EHS Adapter	EHS-24
TOSHIBA DP5022-SD, DP5022-SDM, DP5032-SD, DP5122-SD, DP5130-FSDL, DP5130-SDL, DP5132-SD, IP5022-SD, IP5122-SD, IP5122-SDC, IP5131-SDL, IP5132-SD, IPT2008-SDL, IPT2010-SD, IPT2020-SD	Adapter Kit	EHS-8
YEALINK *T27G, *T27P, *T29G, *T40G, *T40P, *T41S, *T41P, *T42G, *T42S, *T46G, *T46S, * T48S	DS-Gender *Needs Yealink EHS Adapter	EHS-6
YEALINK T52S, T54W	USB A-type	EHS-28
SMART PHONE Galaxy & iPhone Series 4~6+	3.5 phi Connector EHS Adapter	EHS-9
PC PC with a USB port	USB A-type	EHS-30

Aastra/Mitel EHS setup guide

Aastra / Mitel	Phones
	5370/5370ip 5380/5380ip6739i 6771/6773/6773ip 6775/6775ip 7434ip/7444ip

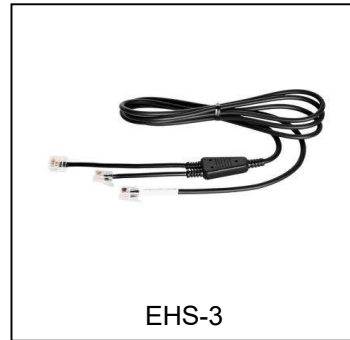

Connection Diagram

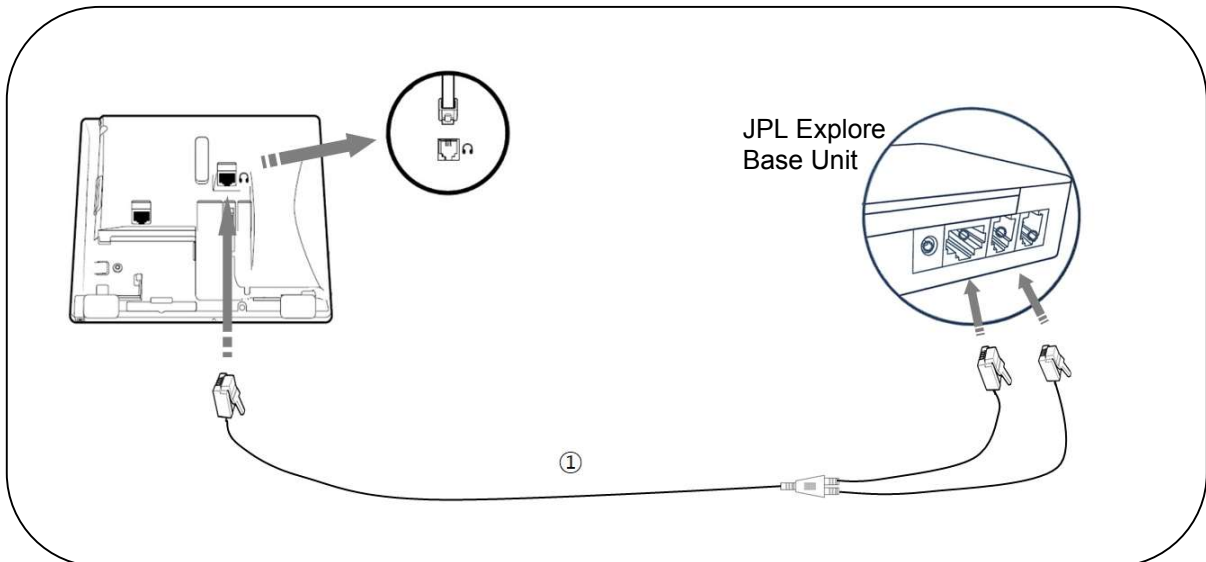

① : EHS Cable(EHS-3) : RJ-45(8P8C) to RJ-45(8P8C) and RJ-9(4P4C)



Connection Diagram

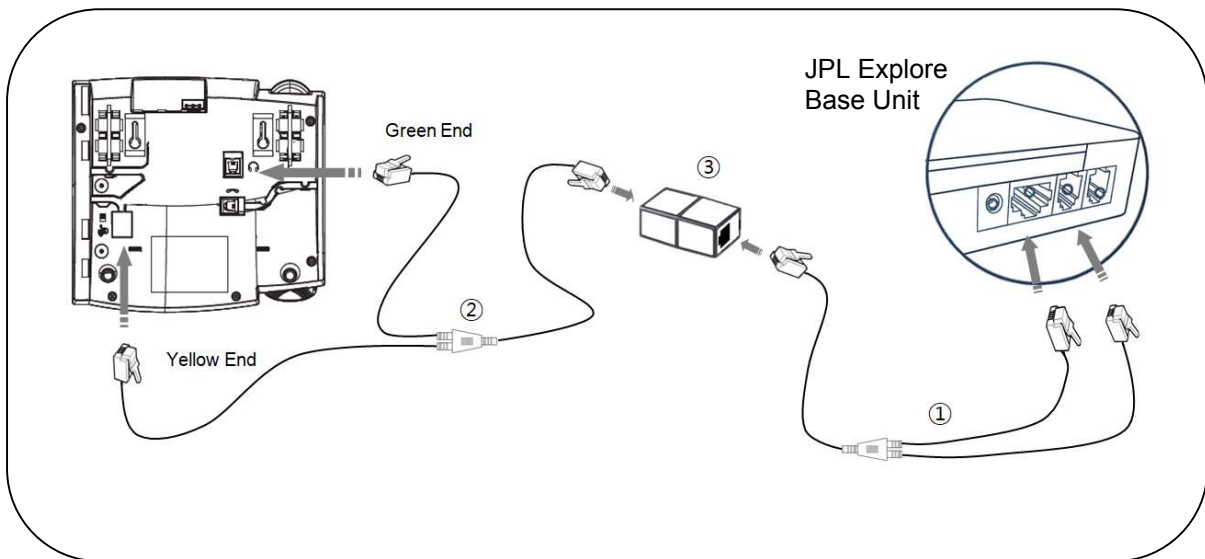

- Note : Astra(Mitel) DHSG cable kit is available from your Astra(Mitel) reseller
- ① : EHS cable(EHS-3) : RJ-45(8P8C) to RJ-45(8P8C) and RJ-9(4P4C)
- ② : Astra(Mitel) DHSG cable : available from your reseller
- ③ : RJ-45 Coupler : available from your reseller

Aastra/Mitel EHS setup guide

Aastra/Mitel	Phones
	5370/5370ip 5380/5380ip6739i 6771/6773/6773ip 6775/6775ip 7434ip/7444ip



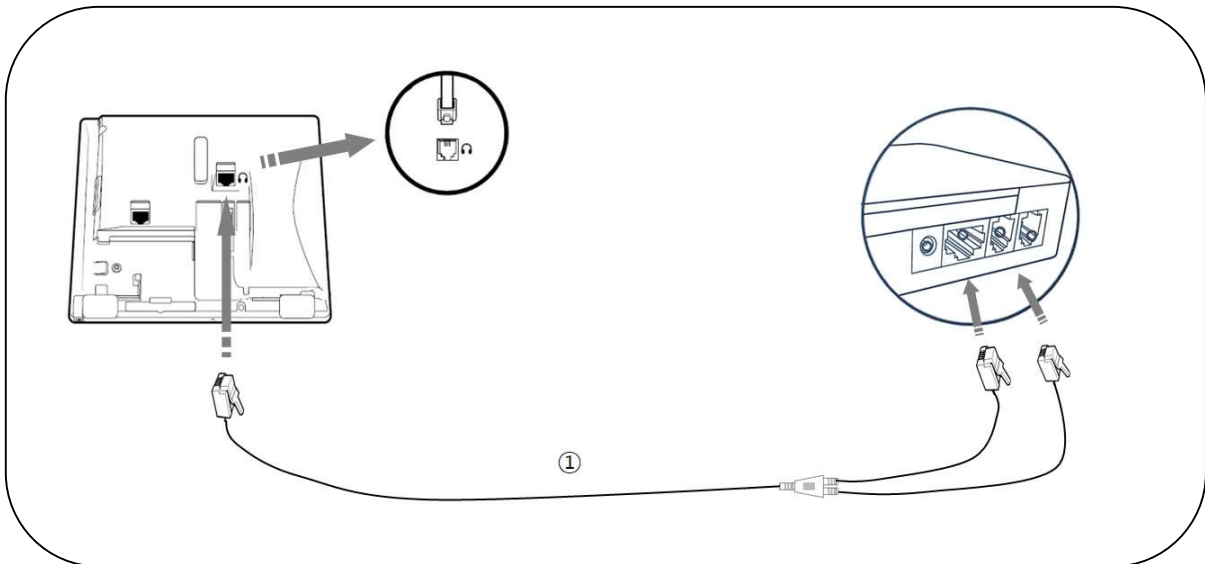

EHS-3

Connection Diagram

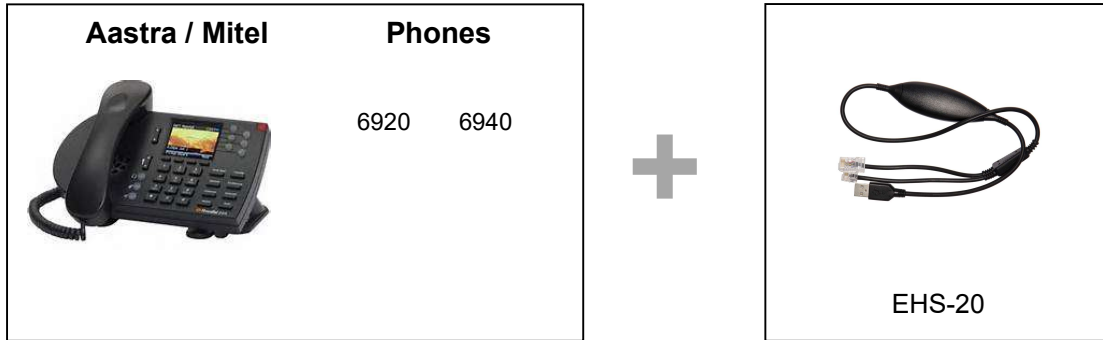

① EHS Cable(EHS 3) : RJ-45(8P8C) to RJ-45(8P8C) and RJ-9(4P4C)

Mitel EHS setup guide



Connection Diagram

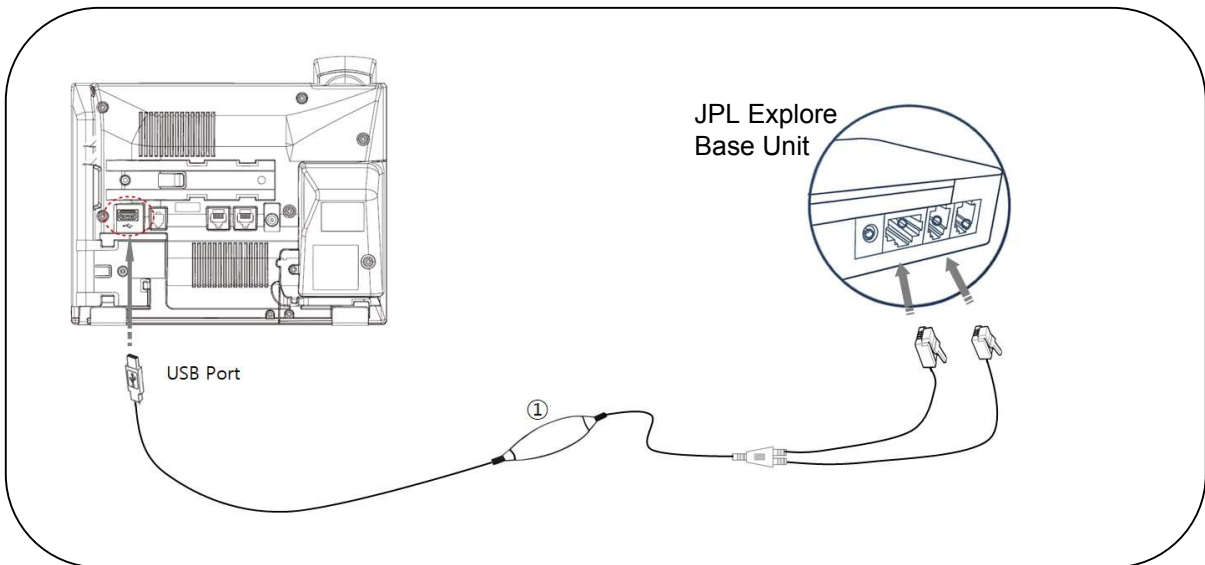

① : EHS Adapter(EHS-20) : USB A-type to RJ-45 and RJ-9

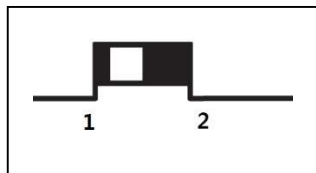

Position of Telephone Compatibility Switch : Set to '1'.
Compatibility switch is located on left side of the JPL Explore base unit.

Alcatel EHS Setup guide



Connection Diagram

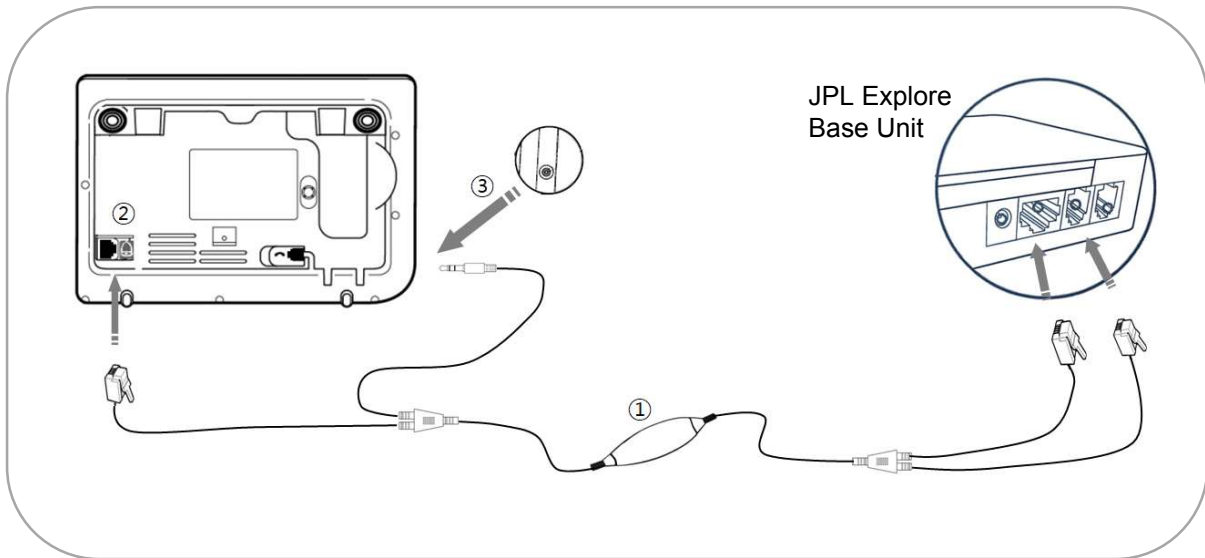

- ① : EHS Adapter(EHS-7) : RJ-12(6P6C) and 3.5Ø plug to RJ-45(8P8C) and RJ-9(4P4C)
- ② : External ring jack
- ③ : Headset Port : 3.5Ø plug 3-poles

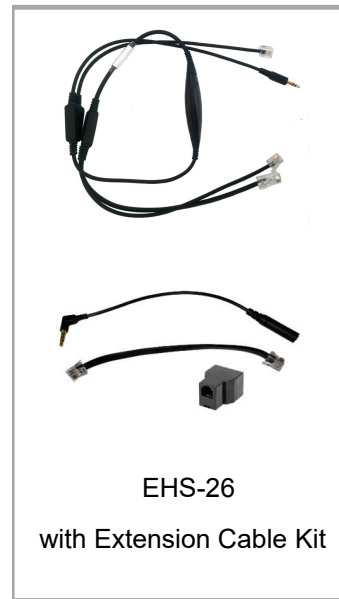

Connection Diagram for 8019s

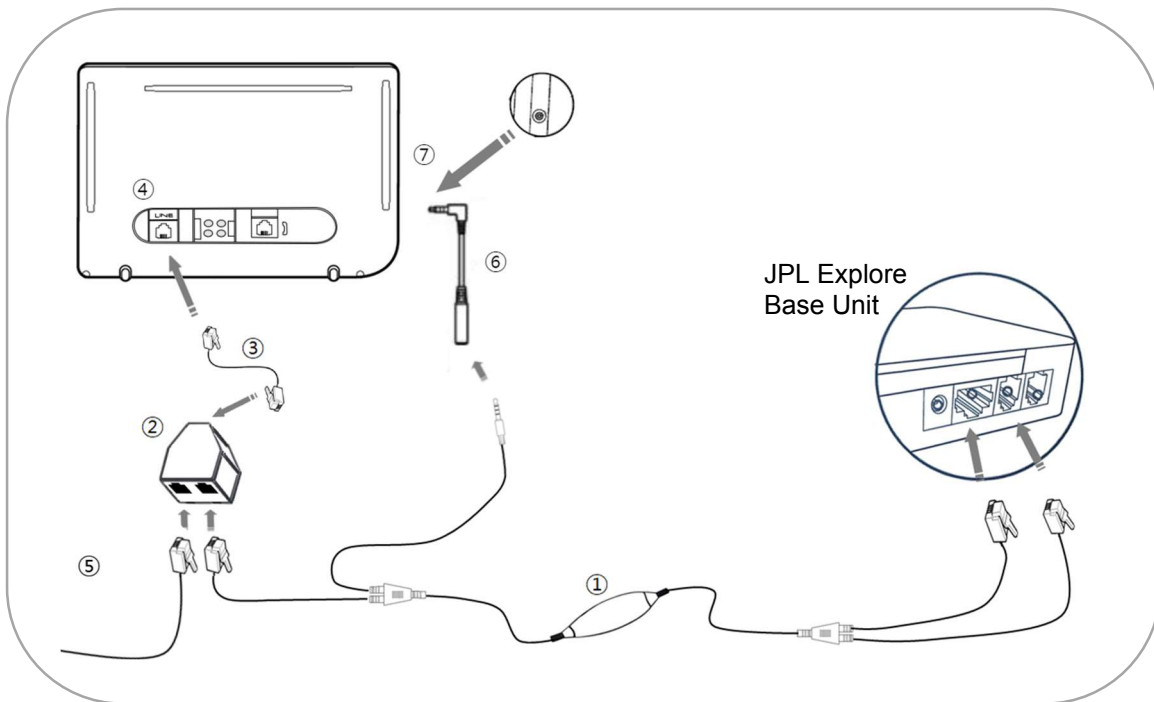

- Note : Need to turn off forced headset mode in settings

- ① : EHS Adapter(EHS-26) : RJ12(6P6C) and 3.5Ø plug to RJ45(8P8C) and RJ9(4P4C)
- ② : RJ12(6P6C) Splitter
- ③ : Telephone cord (RJ12 to RJ12)
- ④ : RJ11 Connector for external ringer and audio active envelope indicator
- ⑤ : Alcatel-Lucent Switch Box external cable plug
- ⑥ : Phone Jack zender : 3-poles to 4-poles
- ⑦ : Headset Port : 3.5Ø plug 4-poles

Connection Diagram for 8029s, 8039s

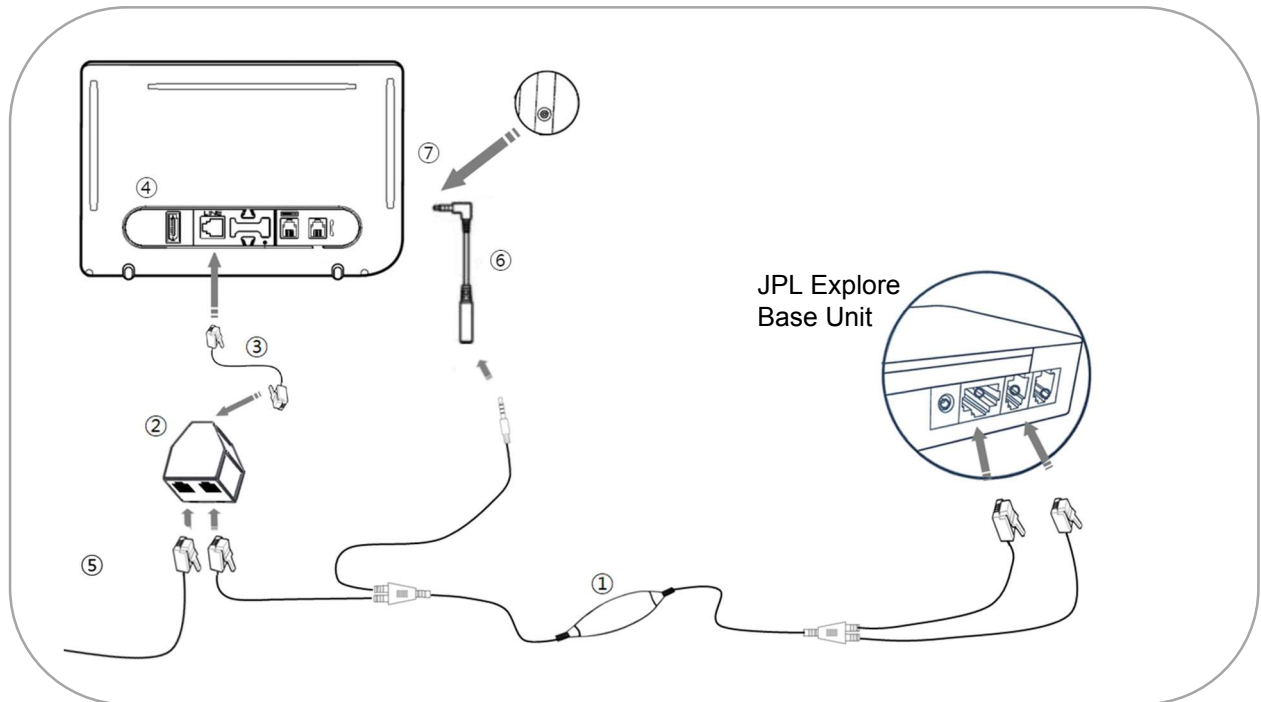

- ① : EHS Adapter(EHS-26) : RJ12(6P6C) and 3.5Ø plug to RJ45(8P8C) and RJ9(4P4C)
- ② : RJ12(6P6C) Splitter
- ③ : Telephone cord (RJ12 to RJ12)
- ④ : RJ11 Connector for external ringer and audio active envelope indicator
- ⑤ : Alcatel-Lucent Switch Box external cable plug
- ⑥ : Phone Jack zender : 3-poles to 4-poles
- ⑦ : Headset Port : 3.5Ø plug 4-poles



Connection Diagram

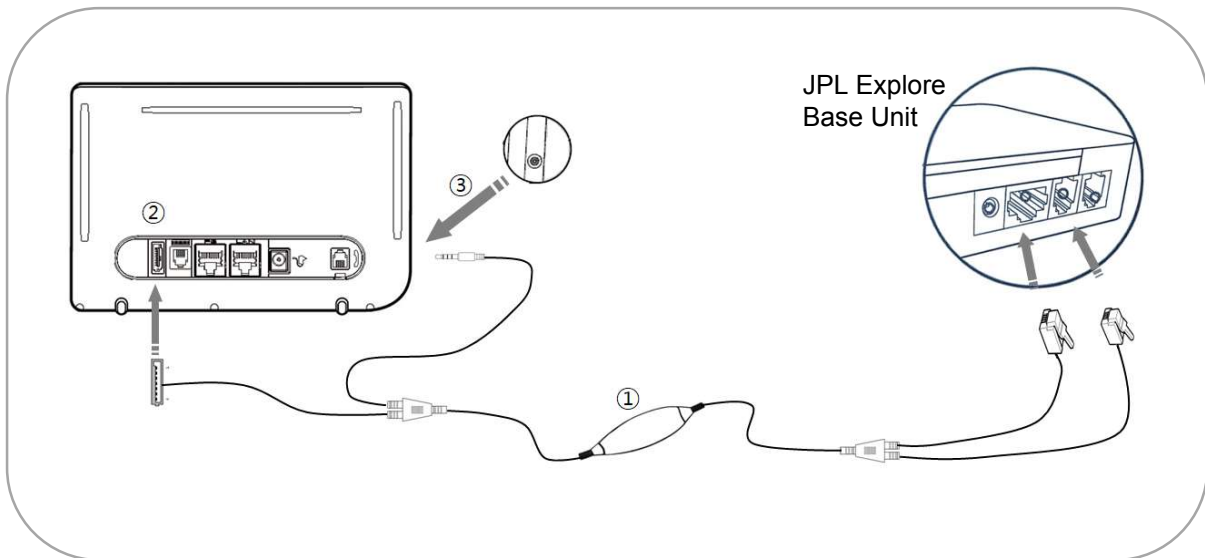

- ① : EHS Adapter(EHS-18) : SATA connector and 3.5Ø plug to RJ-45(8P8C) and RJ-9(4P4C)
- ② : External ring connector : SATA type
- ③ : Headset Port : 3.5Ø plug 4-poles

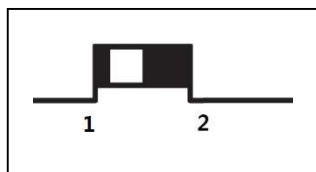

Position of Telephone Compatibility Switch : Set to '1'.
Compatibility switch is located on left side of the JPL Explore base unit.

Allworx EHS Setup guide

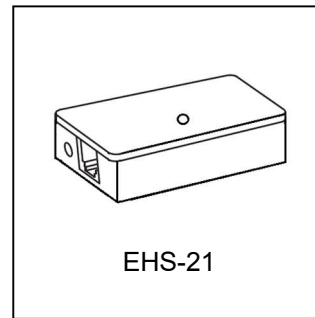

Connection Diagram

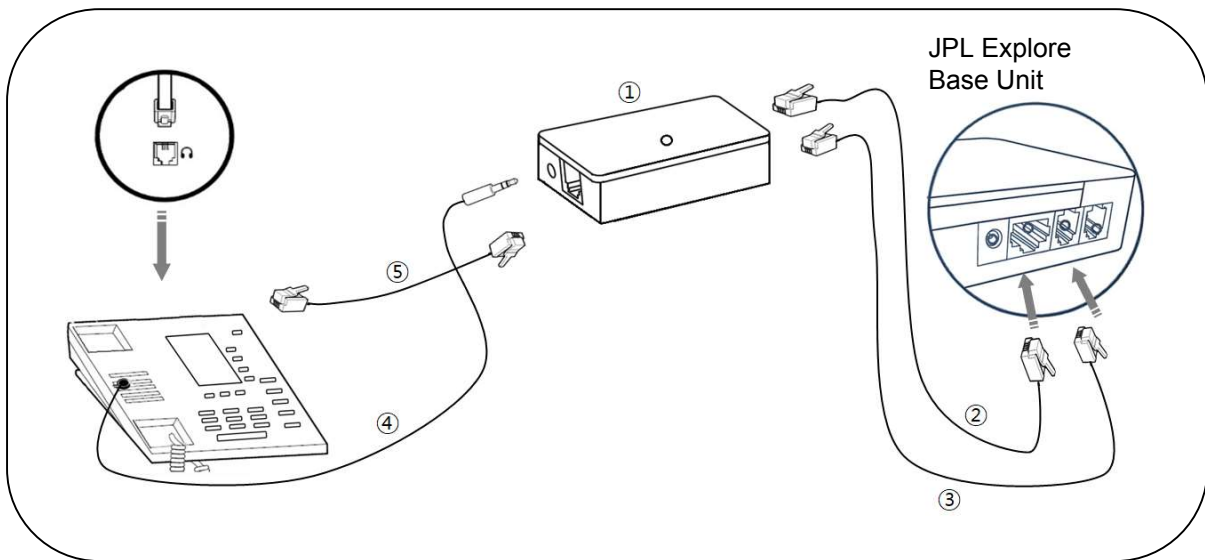

- ① : EHS Adapter(EHS-21)
- ② : Power cable (RJ-45 to RJ-45) : Cable length : 600mm
- ③ : Telephone cord (RJ-9 to RJ-9) : Cable length : 600mm
- ④ : External Microphone : For ring detection
- ⑤ : Telephone cord (RJ-9 to RJ-9) : Cable length : 300mm

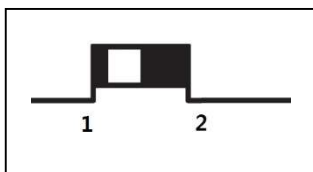

Position of Telephone Compatibility Switch : Set to '1'.
Compatibility switch is located on left side of the JPL Explore base unit.

Avaya EHS Setup guide

Avaya	Phones			
	1408	1416	1608	
	1616	2410	5410	
	6224D+M/ 6416D+M			
	9404	9408	9504	
	9508	9608	9610	
	9611	9620	9621	
	9630	9640	9641	
	9650	9670	J179	J100

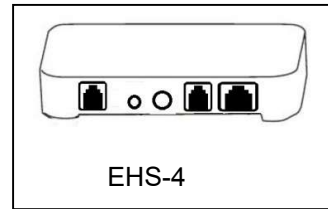

Connection Diagram

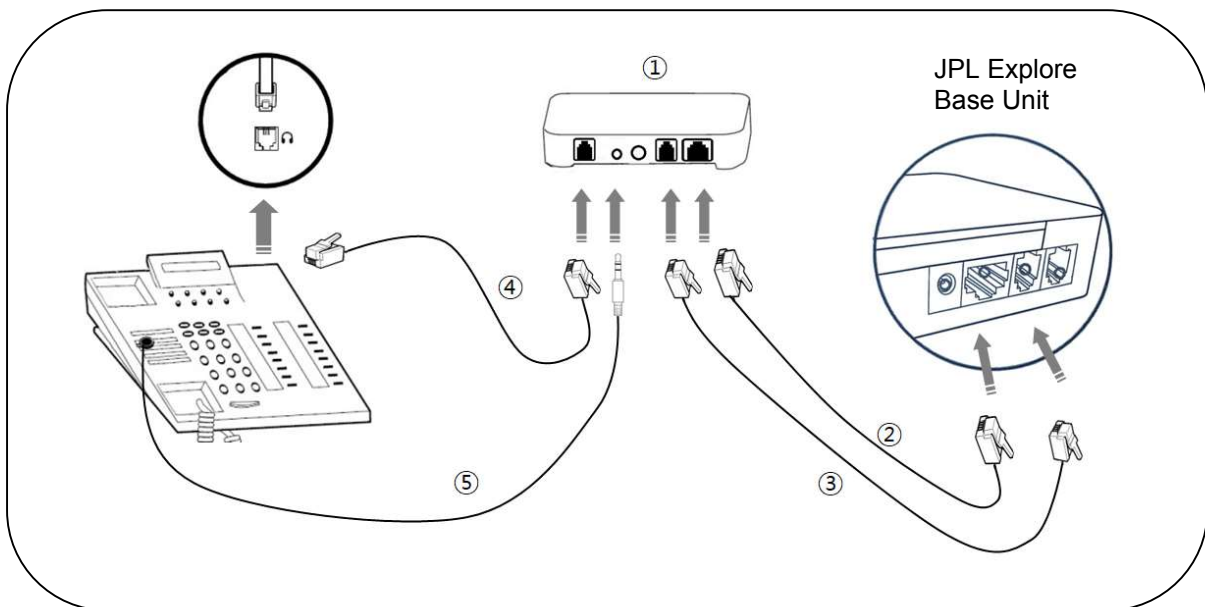

- ① : EHS Adapter (EHS-4)
- ② : Power cable (RJ-45 to RJ-12)
- ③ : Telephone cord (RJ-9 to RJ-9) Cable length : 600mm
- ④ : Telephone cord (RJ-9 to RJ-9) Cable length : 300mm
- ⑤ : External Microphone for ring detection

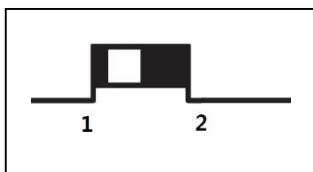

Position of Telephone Compatibility Switch : Set to '1'.
Compatibility switch is located on left side of the JPL Explore base unit.

To configure Avaya IP Desk phones speech path to use the Headset instead of the Speaker, go to: "Menu → Call Settings → Audio Path and select "Headset".

Note: Avaya 1600 Series Desk phones do not provide switching and alerting signaling for headsets.

Avaya EHS Setup guide

Avaya	Phones
	4610/4610SW
	4620/4620SW
	4621/4621SW
	4622/4622SW
	4625/4625SW
	4630/4630SW
	5420/5610/5620/5621/5625



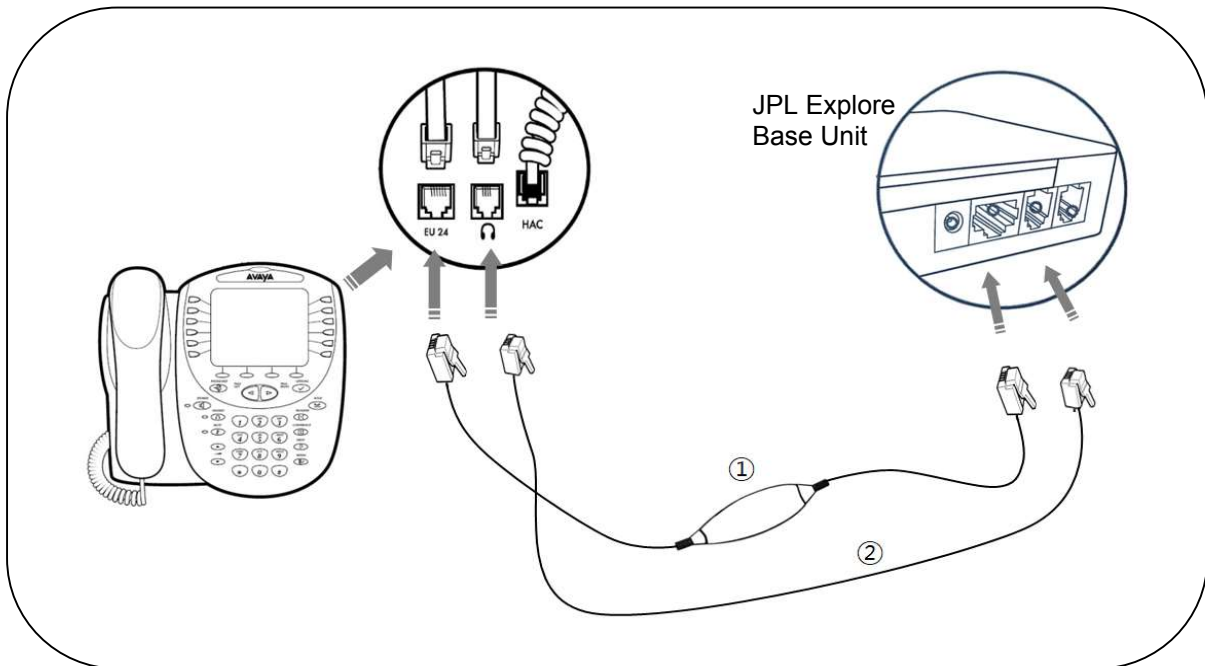

EHS-15

Connection Diagram

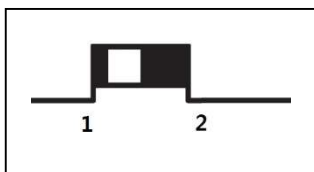

- ① : EHS Adapter(EHS-15) : RJ-45 to RJ-12
- ② : Telephone cord : RJ-9 to RJ-9 Cable length : 600mm



Position of Telephone Compatibility Switch : Set to '1'.
 Compatibility switch is located on left side of the JPL Explore base unit.



Connection Diagram6

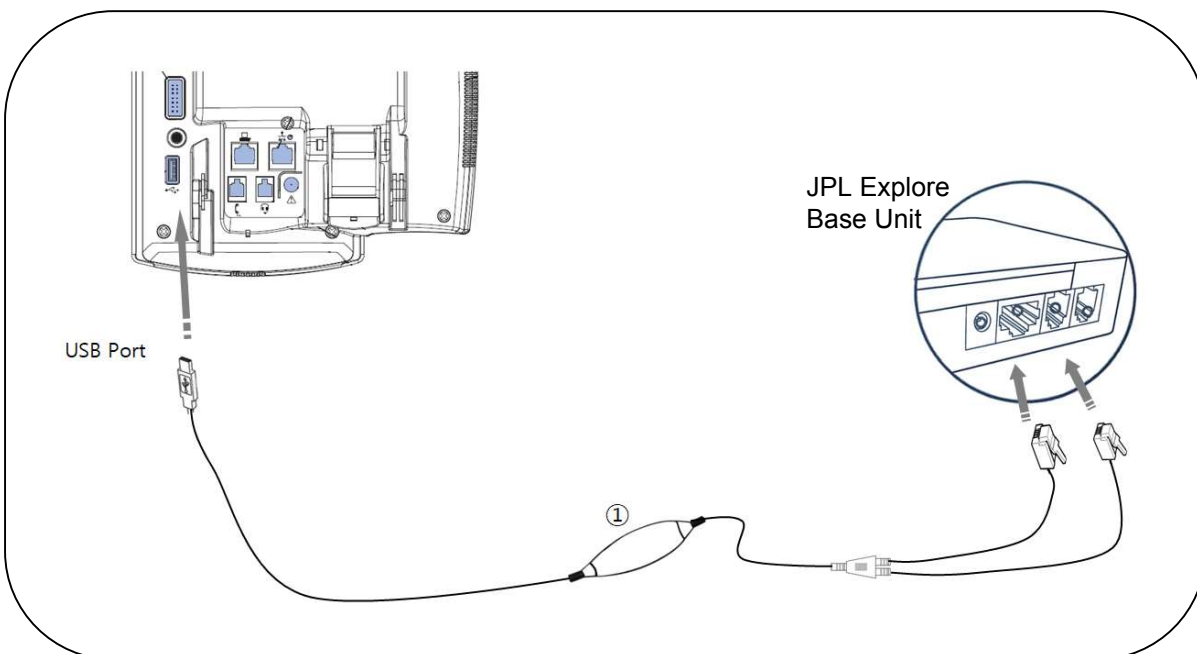

① : EHS Adapter(EHS-25) : USB A-type male to RJ-45 and RJ-9

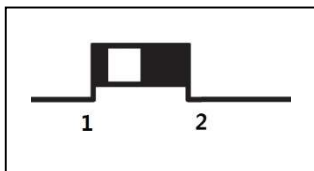

Position of Telephone Compatibility Switch : Set to '1'.
Compatibility switch is located on left side of the JPL Explore base unit.

Cisco EHS Setup guide

Cisco	Phones	
	6821	6945
	6841	7942G 7945G
	6851	7962G 7965G
	6861	7975G
	6871	
		7821/7841/7861
		8811/8841/8845
		8851/8861/8865



Connection Diagram

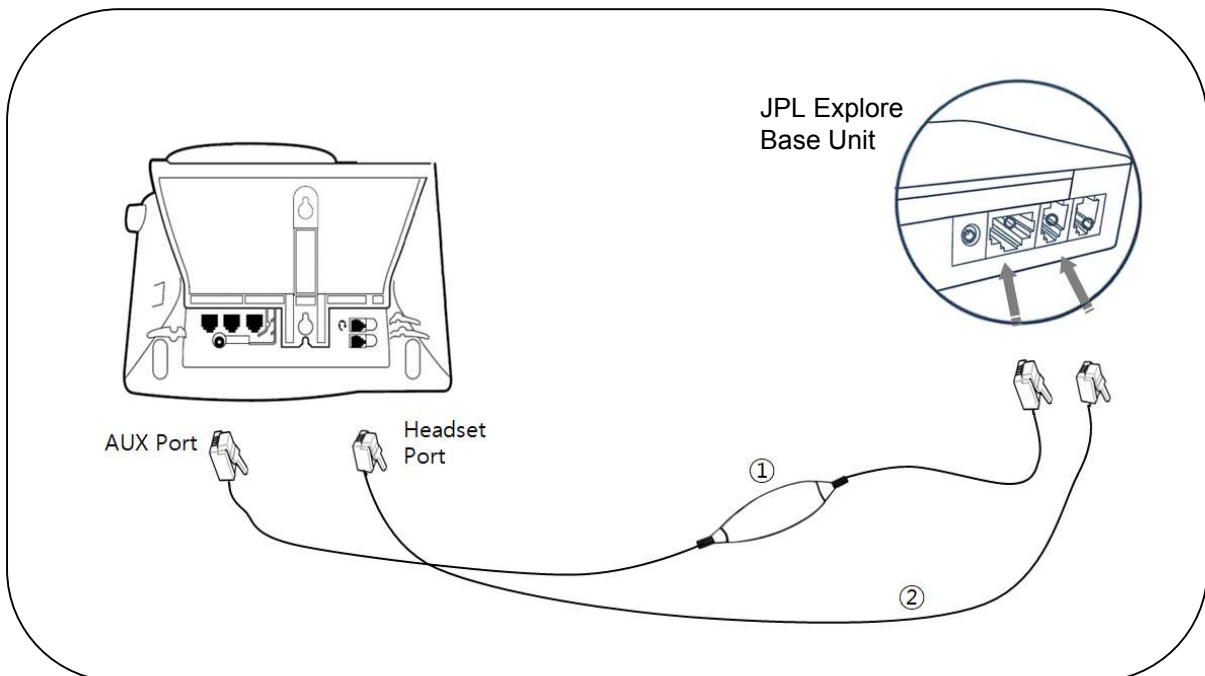

① : EHS Adapter (EHS-2) : RJ-45 to RJ-12

② : Telephone cord (RJ-9 to RJ-9) : Cable length : 600mm

- Note : Make sure that Electronic Hook switch can be enabled in Cisco Unified Communications Manager Administration.

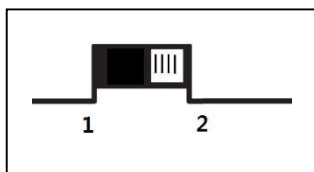

Position of Telephone Compatibility Switch : Set to '2'.
Compatibility switch is located on left side of the JPL Explore base unit.

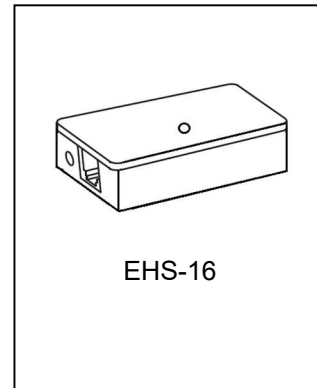

Connection Diagram

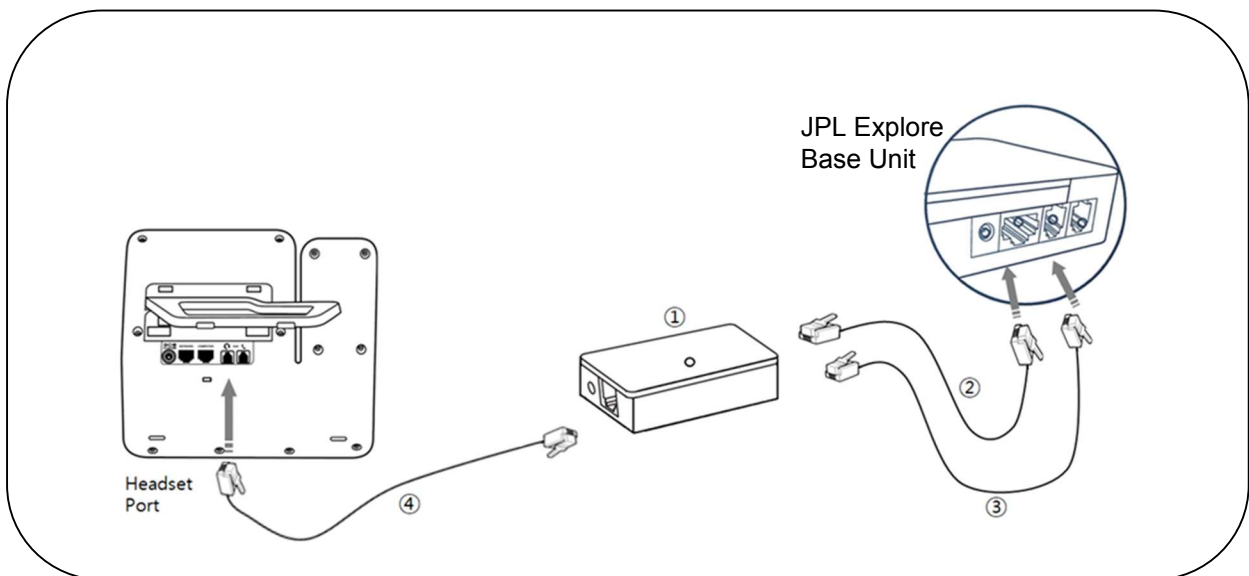

- ① : EHS Adapter (EHS-16)
- ② : Power cord : RJ-45 to RJ-45
- ③ : Telephone cord (RJ-9 to RJ-9) : Cable length : 600mm
- ④ : Telephone cord (RJ-9 to RJ-9) : Cable length : 600mm (Yellow colour cord)

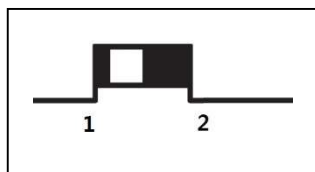

Position of Telephone Compatibility Switch : Set to '1'.
Compatibility switch is located on left side of the JPL Explore base unit.

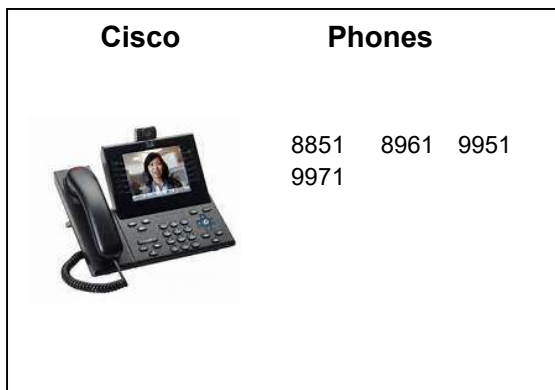

Connection Diagram

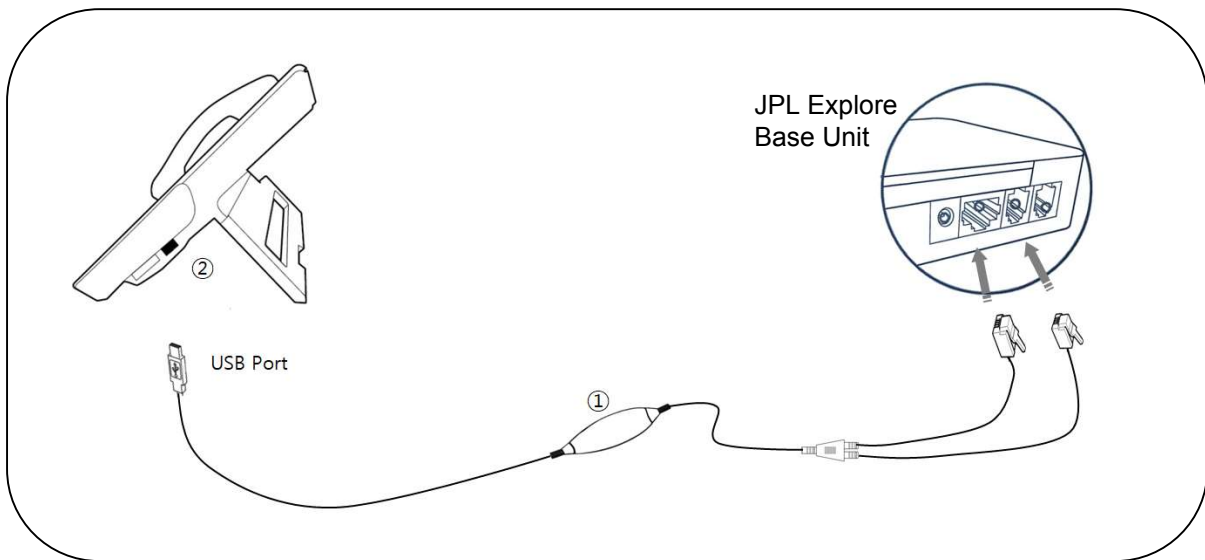

- ① : EHS Adapter (EHS-12) : RJ-45(8P8C) and RJ-9(4P4C) to USB A-type Plug
- ② : USB Port(A-type Female)

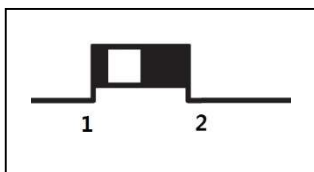

Position of Telephone Compatibility Switch : Set to '1'.
Compatibility switch is located on left side of the JPL Explore base unit.

Ericsson-LG EHS Setup guide



- Note : Needs Ericsson-LG EHSA Kit

Connection Diagram

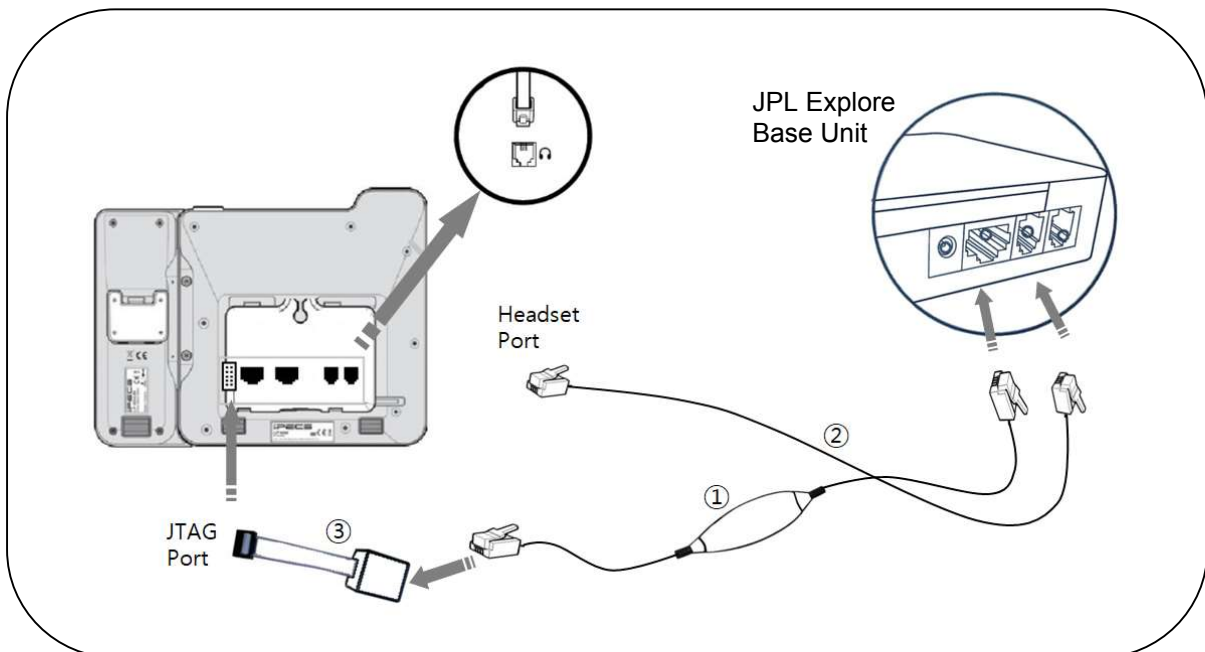

- ① EHS Adapter (EHS-11) : RJ-45(8P8C) to RJ-45(8P8C)
- ② Telephone cord : RJ-9(4P4C) to RJ-9(4P4C)
- ③ LG EHS Adapter : It is available from Ericsson-LG reseller



Connection Diagram

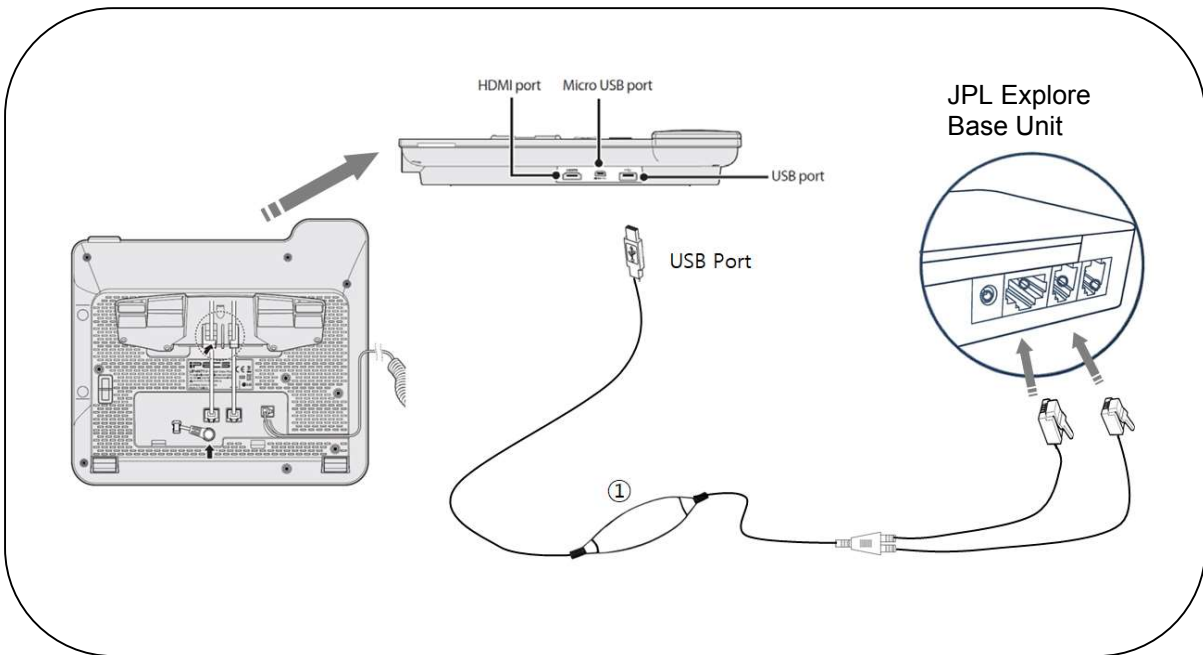

① EHS Adapter (EHS-22) : USB (A-type) to RJ-45(8P8C) and RJ-9(4P4C)

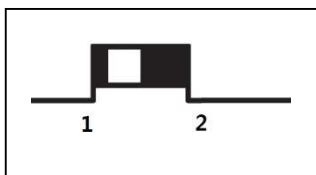

Position of Telephone Compatibility Switch : Set to '1'.
Compatibility switch is located on left side of the JPL Explore base unit.

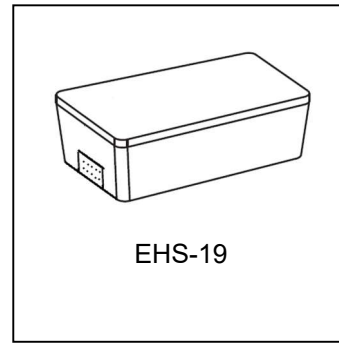

Connection Diagram

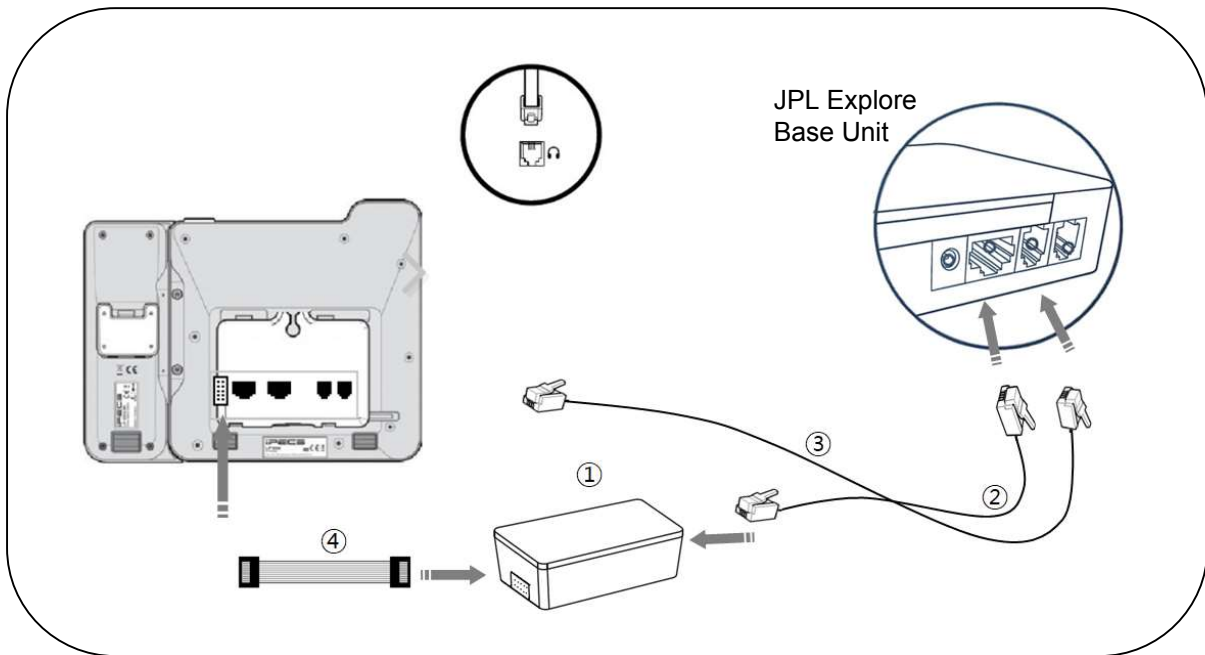

- ① EHS Adapter (EHS-19)
- ② Power cable : RJ-45(8P8C) to RJ-45(8P8C)
- ③ Telephone cord (RJ-9 to RJ-9) Cable length : 600mm
- ④ JTAG cable

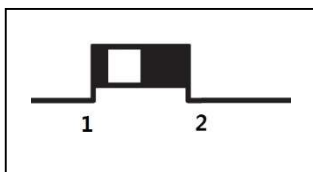

Position of Telephone Compatibility Switch : Set to '1'.
Compatibility switch is located on left side of the JPL Explore base unit.

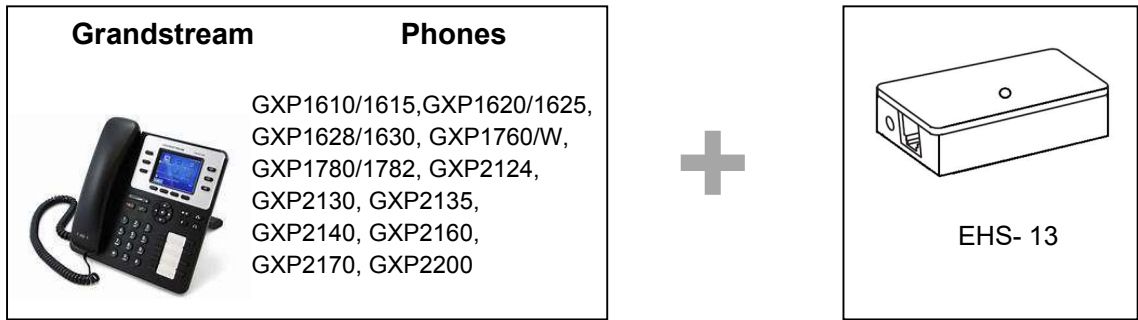

Connection Diagram

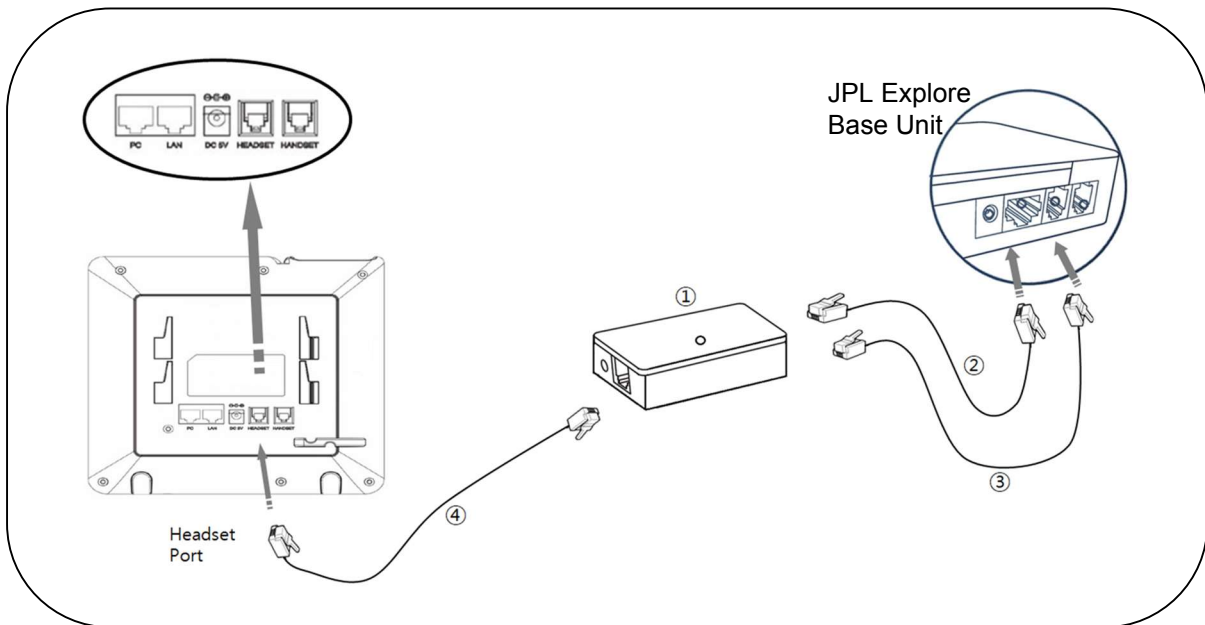

- Note : Phones require firmware 1.0.4.23 or higher
- ① : EHS Adapter (EHS-13)
- ② : Power cord : RJ-45 to RJ-45
- ③ : Telephone cord (RJ-9 to RJ-9) : Cable length : 600mm
- ④ : Telephone cord (RJ-9 to RJ-9) : Cable length : 600mm

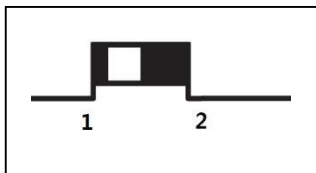

Position of Telephone Compatibility Switch : Set to '1'.
 Compatibility switch is located on left side of the JPL Explore base unit.

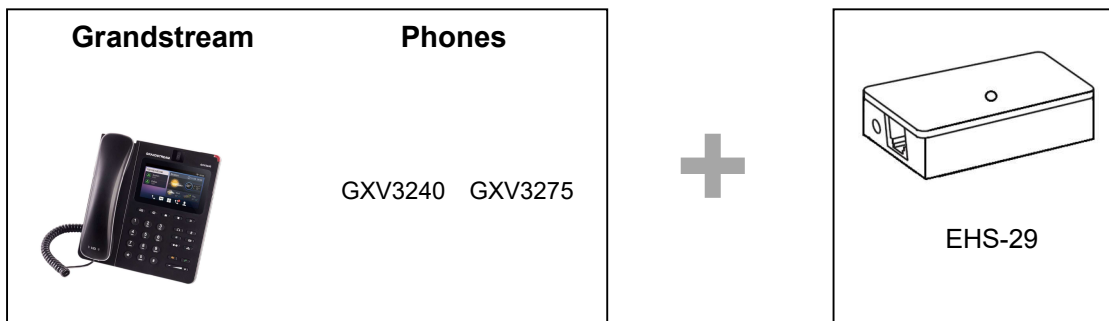

Connection Diagram

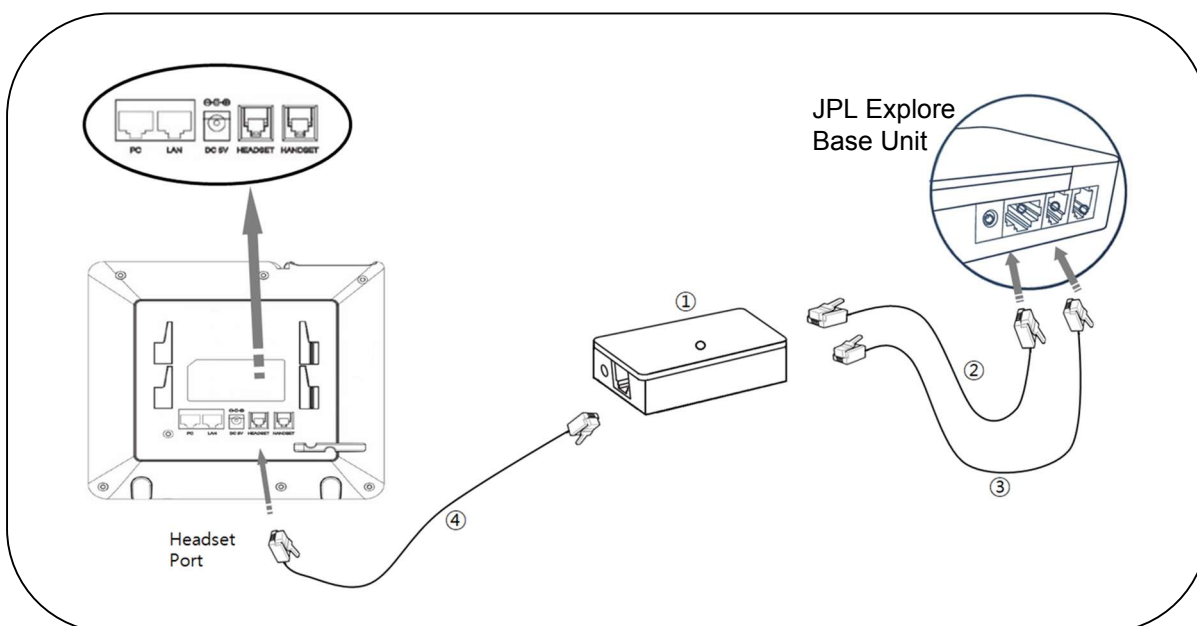

● Note : Phones require firmware 1.0.4.23 or higher

- ① : EHS Adapter (EHS-29)
- ② : Power cord : RJ-45 to RJ-45
- ③ : Telephone cord (RJ-9 to RJ-9) : Cable length : 600mm
- ④ : Telephone cord (RJ-9 to RJ-9) : Cable length : 600mm

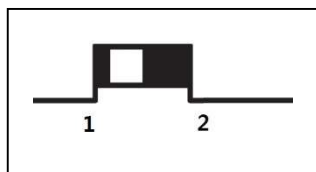

Position of Telephone Compatibility Switch : Set to '1'.
Compatibility switch is located on left side of the JPL Explore base unit.

HTEK EHS Setup guide

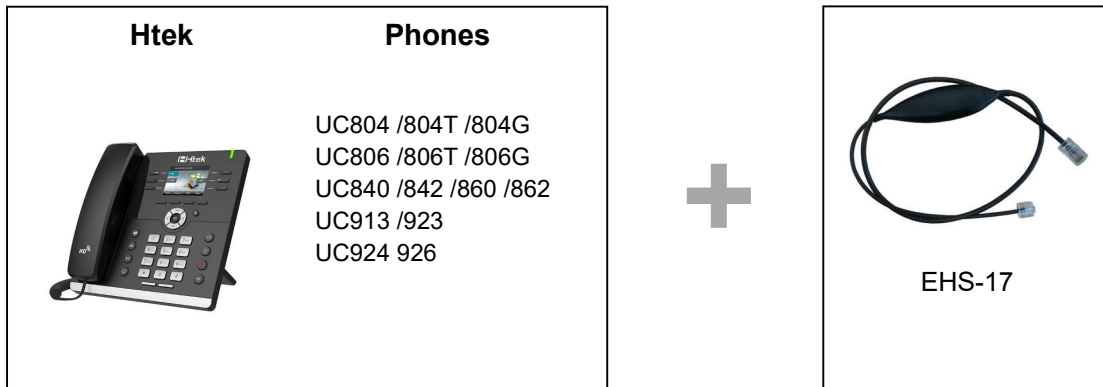

Connection Diagram

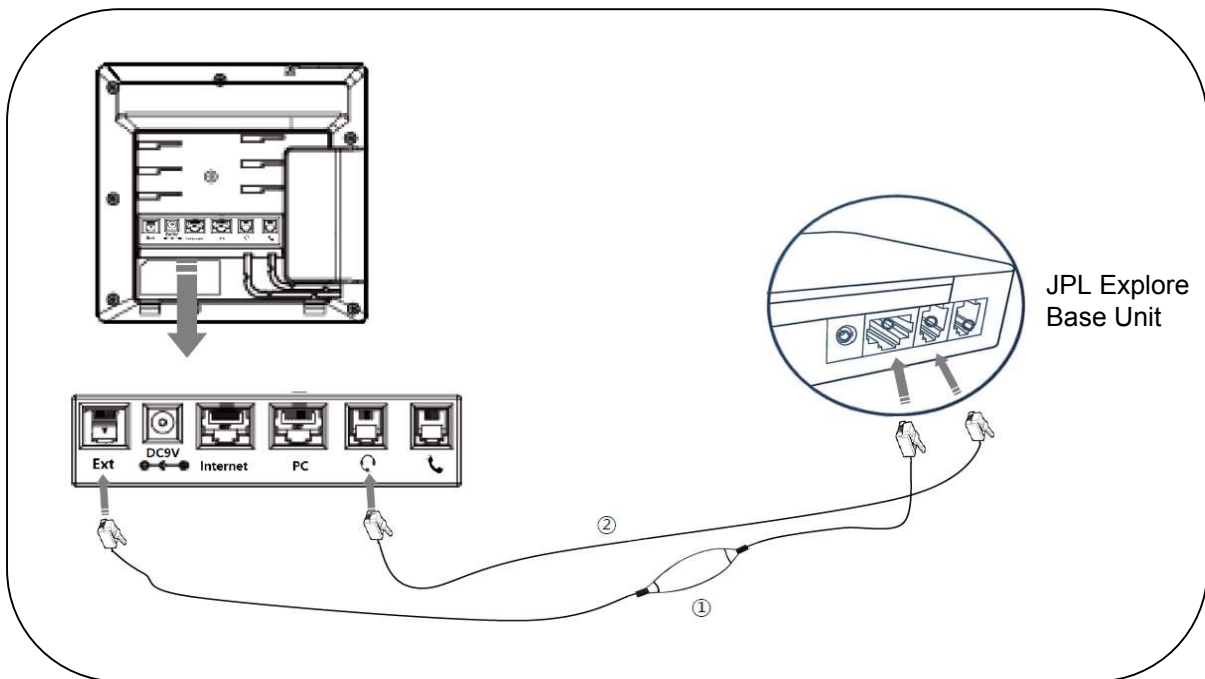

- ① : EHS Adapter (EHS-17) : RJ-45 to RJ-12
- ② : Telephone cord (RJ-9 to RJ-9) Cable length : 600mm

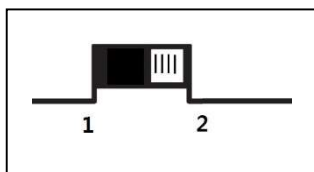

Position of Telephone Compatibility Switch : Set to '2'.
Compatibility switch is located on left side of the JPL Explore base unit.

NEC EHS Setup guide

NEC	Phones
	(DT330 Series) DTL-12D-1 / DTL-24D-1 / DTL-8LD-1
	(DT430 Series) DTZ-12D-1 / DTZ-24D-1 / DTZ-8LD-1
	(DT730 Series) ITL-12D-1 / ITL-12DG-1 / ITL-12CG-1 ITL-24D-1
	(DT830 Series) ITZ-12D-1 / ITZ-24D-1 / ITZ-8LD-1
	(DT830G Series) ITZ-12DG-1 / ITZ-24DG-1 / ITZ-8LDG-1

+



EHS-27

Connection Diagram

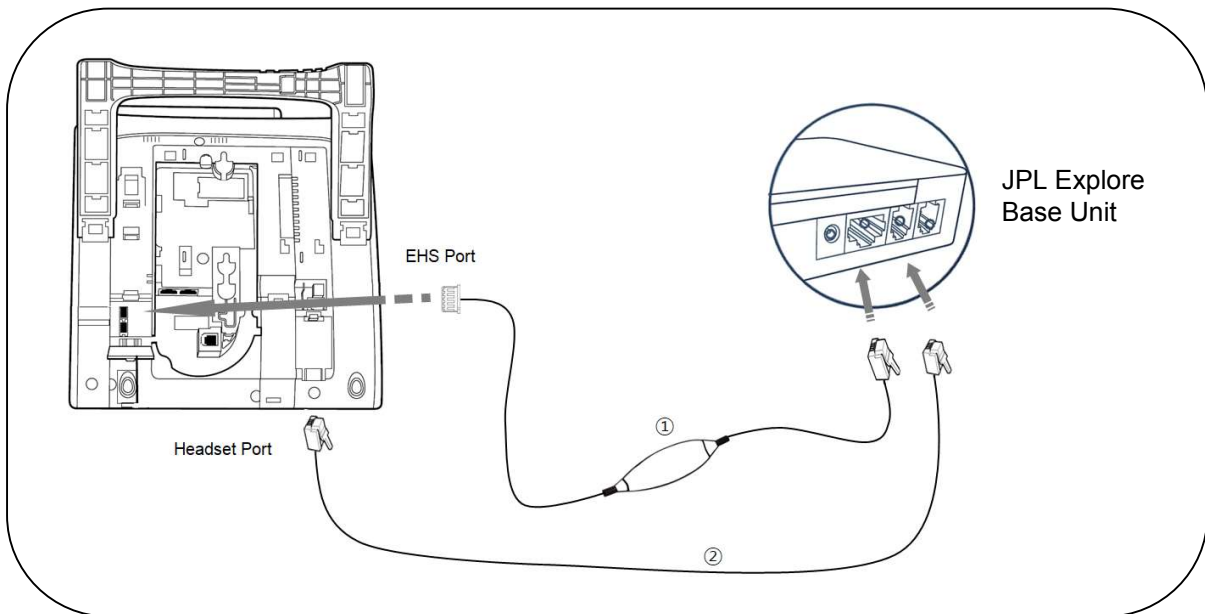

- ① EHS Adapter(EHS-27) : RJ-45 to Double Row Socket (2 x 5)
- ② Telephone cord (RJ-9 to RJ-9) : Cable length 600mm

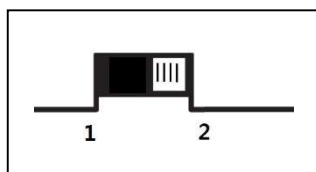

Position of Telephone Compatibility Switch : Set to '2'.
 Compatibility switch is located on left side of the JPL Explore base unit.

Enabling Headset on NEC phones

1. Press "Menu"
2. Select 4 AdminSettings>Maintenance
>Connector Mode>select Headset kit, press OK >press Exit > press Yes restart phone.
3. Press "Menu" > select 3 User Settings>Headset>select 1 Enable > press OK to save setting.
4. Press "Menu" > select 3 User Settings>select ringing. Choose which tune you would like for; 1. Phone, 2. Headset, 3. Phone and Headset > press OK to save setting.
5. Connect EHS Adapter to the vertical double port on the back of the phone.

Panasonic EHS setup guide

Panasonic Phones



NT553 NT556
DT543 DT546
HDV230



EHS-1

Panasonic Phones



NT543



EHS-14

Connection Diagram

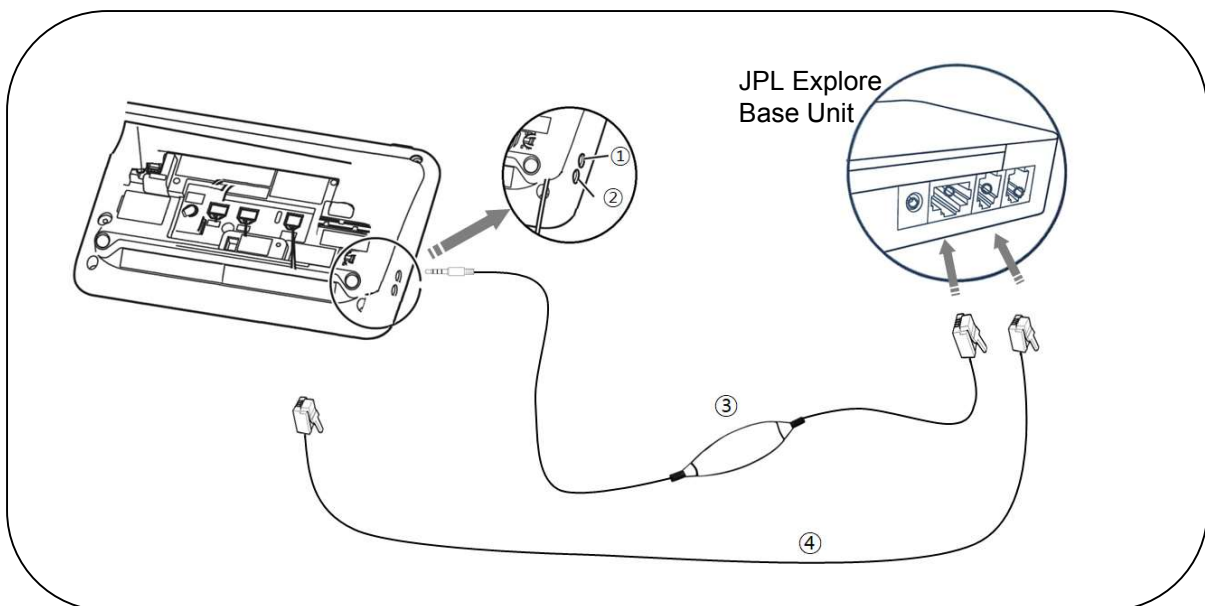

- ① Panasonic EHS Adapter : RJ-45(8P8C) to 3.5Ø Plug (4 poles for EHS-1, 3 poles for EHS-14)
- ② Headset Port (Do not use this port with EHS Adapter at the same)
- ③ EHS Port
- ④ Audio cable : RJ-9(4P4C) to RJ-9(4P4C) : To Handset port

Note : Default Audio cable is RJ-9(4P4C) to RJ-9(4P4C).

The phone doesn't support both the EHS and 2.5mm headset at the same.

To use the EHS with wireless headset you must disconnect the handset from the phone, plug a RJ-9 cable from the phone to the base unit and the plug the handset into the base unit.

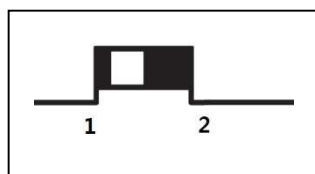

Position of Telephone Compatibility Switch : Set to '1'.
Compatibility switch is located on left side of the JPL Explore base unit.

Polycom EHS Setup guide

Polycom	Phones
 VVX 101 / 150 / 201 / 250 VVX 300 / 301 / 310 / 311 / 350 VVX 400 / 401 / 410 / 411 / 450 / 500 VVX 600, VVX 1500	IP 320 IP 321
	IP 330 IP 331
	IP 335 IP 435
	IP 450 IP 550
	IP 560 IP 650
	IP 670



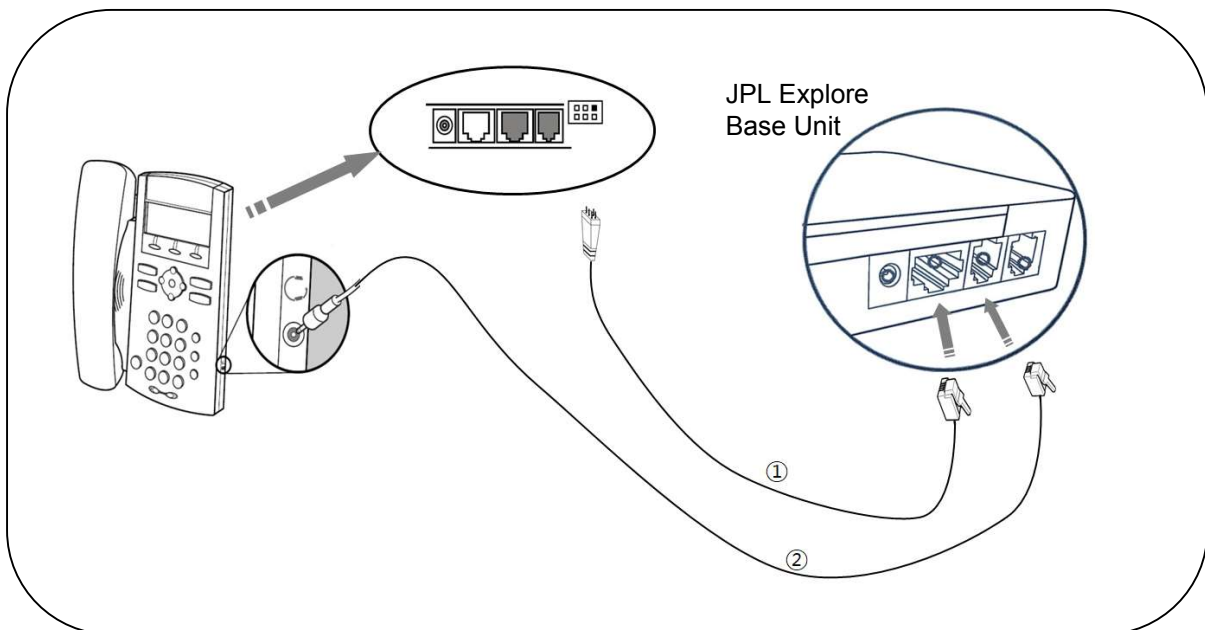

EHS-5

Connection Diagram for IP320/321/330/331

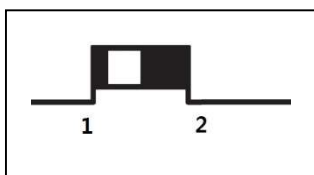

- ① Polycom EHS Adapter (EHS-5) : RJ-45(8P8c) to 5-Pin Plug
- ② Audio cables : RJ-9(4P4C) to 2.5mm Plug (3 poles)
- ③ Headset Port
- ④ EHS Port



Position of Telephone Compatibility Switch : Set to '1'.
 Compatibility switch is located on left side of the JPL Explore base unit.

Connection Diagram for VVX series

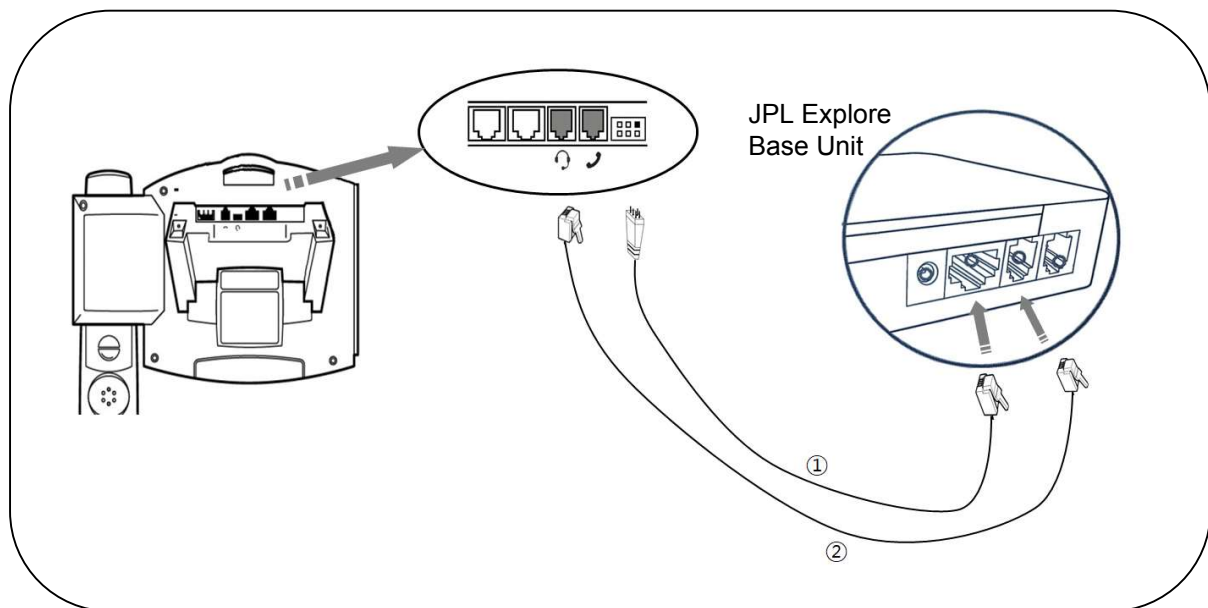

- ① Polycom EHS Adapter (EHS-5) : RJ-45(8P8c) to 5-Pin Plug
- ② Audio cables : RJ-9(4P4C) to RJ-9(4P4C)
- ③ EHS Port

Note 1: Phone must be running SIP application 3.1 or higher and BootROM 4.1.0 or later.

Note 2: Phone must be running SIP application 3.0.2 or higher and BootROM 4.1.0 or later.

Note 3: Phone must be running SIP application 3.1.0 Rev C or higher and BootROM 4.1.0 or later.

Note 4: 2.5mm headset port connector requires Audio cable for IP 320/321/330/331 models

Instruction

Access your Polycom phone menu and change the headset settings to "Jabra Mode" or "Jabra DHSG" based on the manufacturer's instructions for your specific model. Depending on your phone model, you may need to complete this step after connecting the EHS adapter. Typically, changing the settings requires that you access the "Basic," "Preferences," and "Headset" sections in the menu on your phone. Once "Analog Headset Mode" appears on the screen, use the up and down arrows to select the Jabra Mode and then choose "Back," "Exit" or "Menu" to return to the main screen.

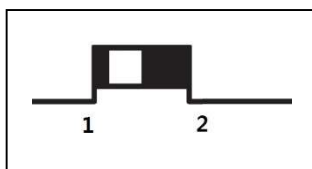

Position of Telephone Compatibility Switch : Set to '1'.
Compatibility switch is located on left side of the JPL Explore base unit.

ShoreTel EHS Setup guide

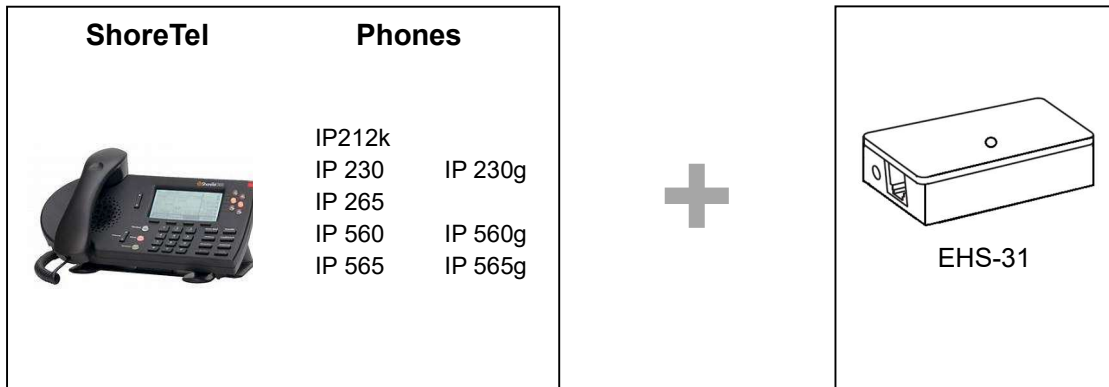

Connection Diagram

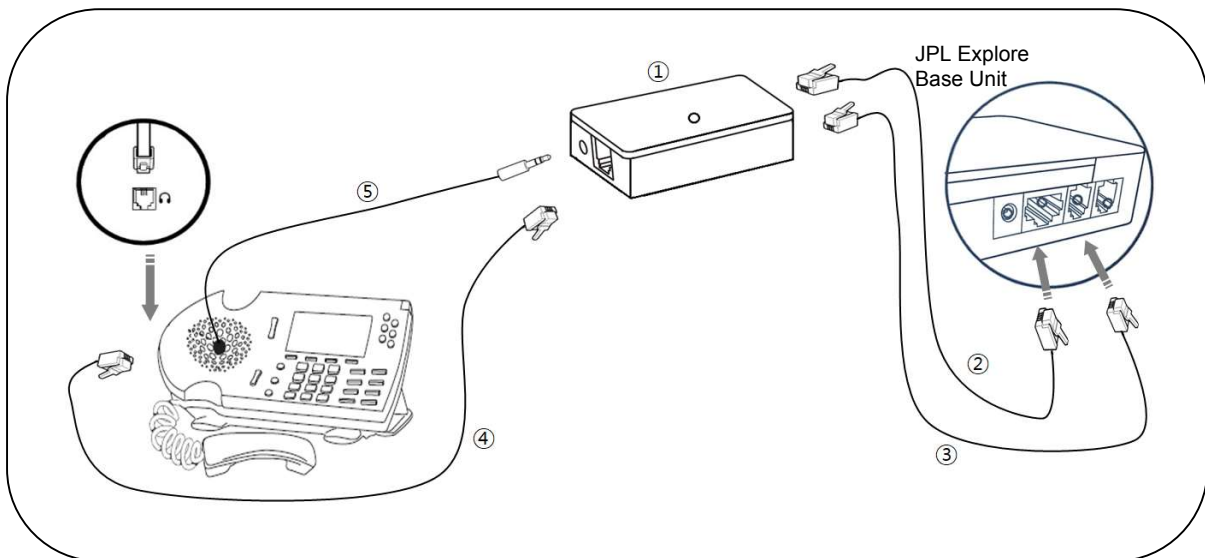

- ① EHS Adapter(EHS-31)
- ② Power cable (RJ-45 to RJ-45)
- ③ Telephone cord (RJ-9 to RJ-9) : Cable length : 600mm
- ④ Telephone cord (RJ-9 to RJ-9) : Cable length : 600mm
- ⑤ External Microphone : For ring detection

Siemens/Unify EHS Setup guide

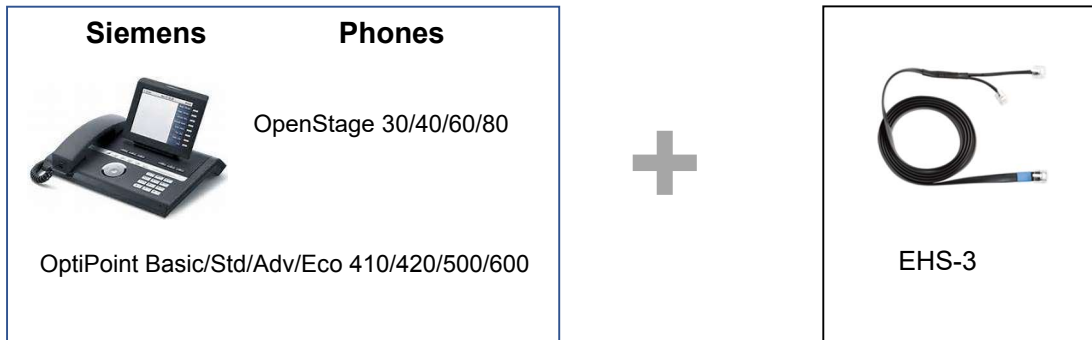

Connection Diagram

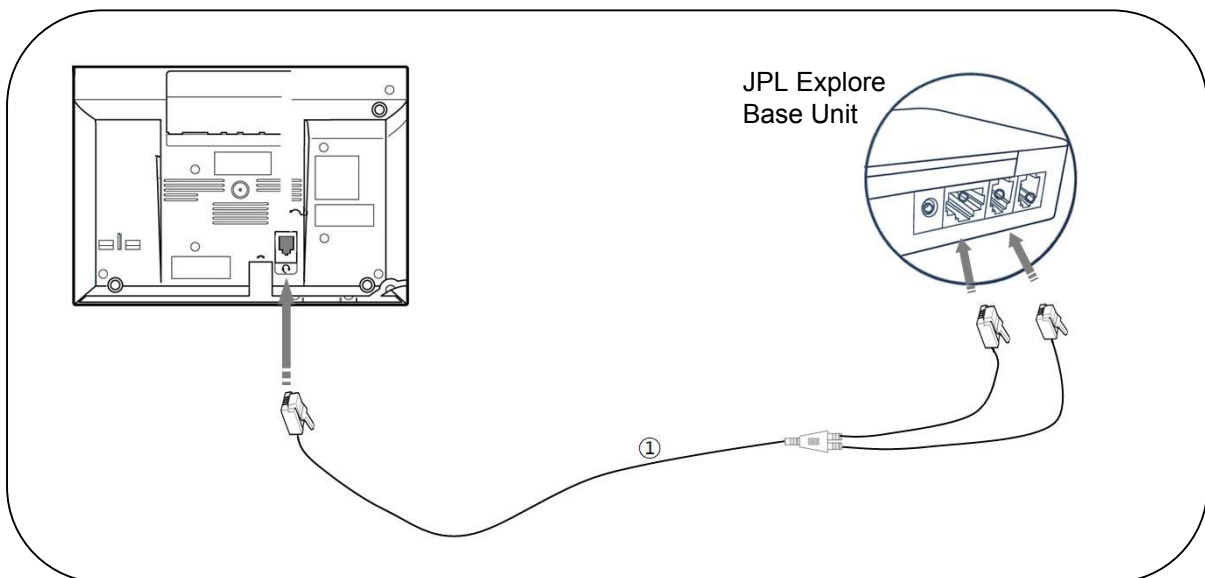

① EHS Adapter (EHS-3) : RJ-45(8P8C) and RJ-9(4P4C) to RJ-45(8P8C)

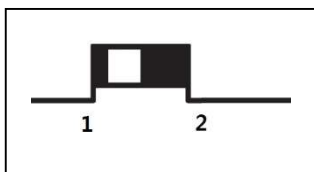

Position of Telephone Compatibility Switch : Set to '1'.
Compatibility switch is located on left side of the JPL Explore base unit.

SNOM EHS Setup guide

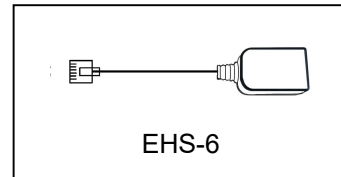

Connection Diagram

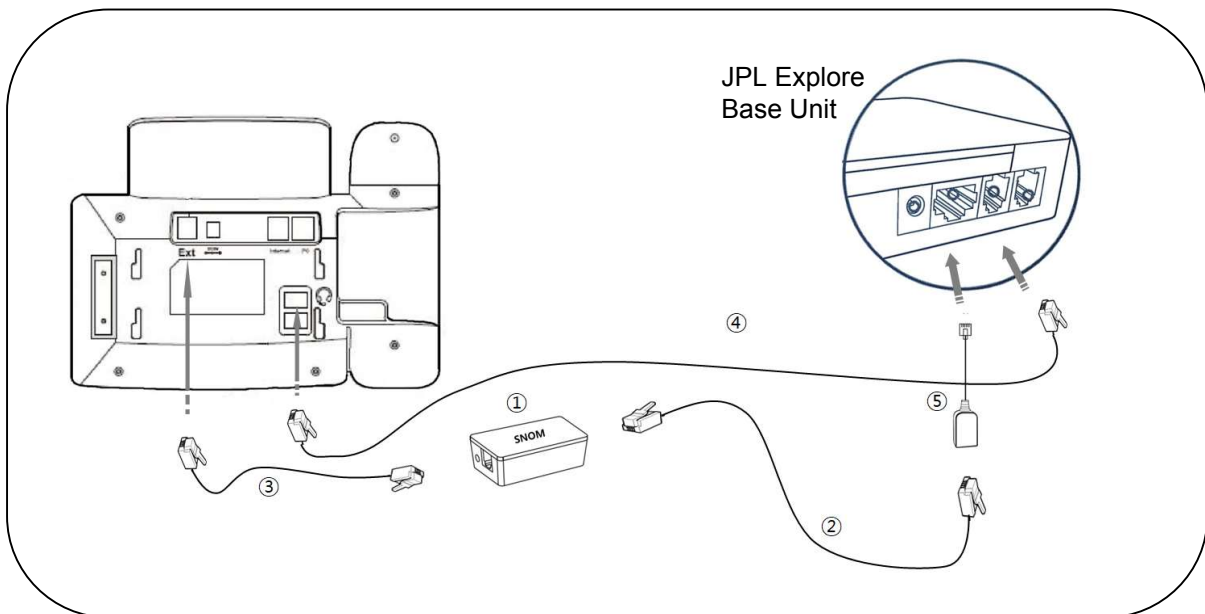

- ① EHS Adaptor(SNOM) : available from Snom reseller
- ② Cord : available from Snom reseller
- ③ Cord : available from Snom reseller
- ④ Cord : available from Snom reseller
- ⑤ EHS Gender(EHS-6)

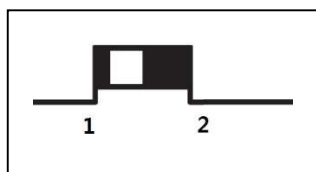

Position of Telephone Compatibility Switch : Set to '1'.
Compatibility switch is located on left side of the JPL Explore base unit.



Connection Diagram

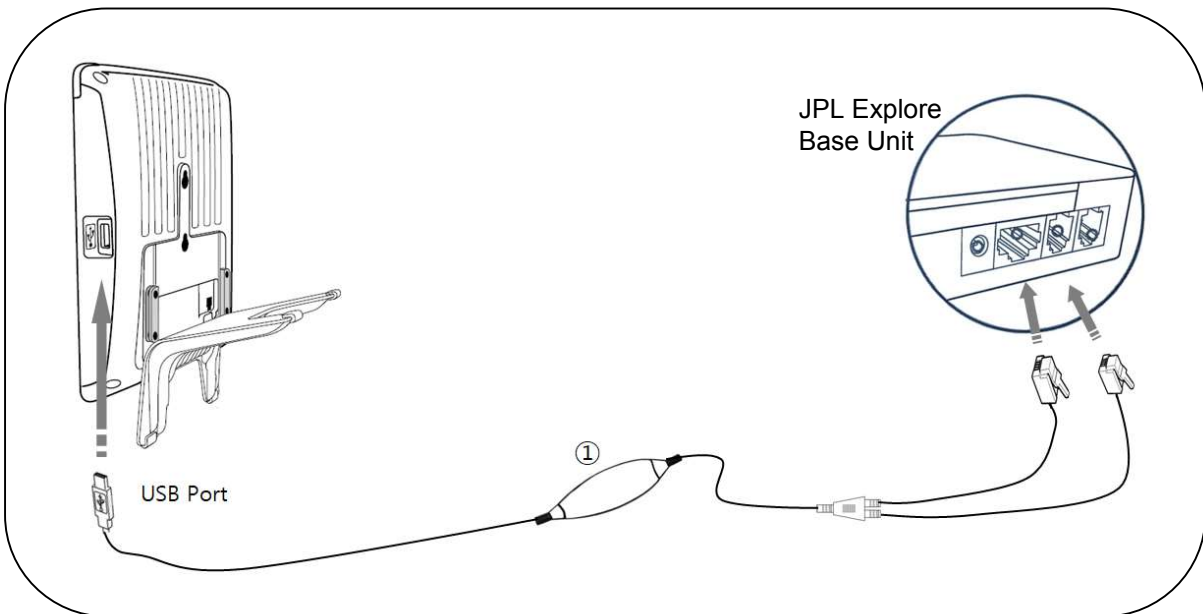

① EHS Adapter(EHS-23) : USB A-type to RJ-45 and RJ-9

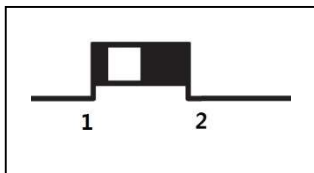

Position of Telephone Compatibility Switch : Set to '1'.
Compatibility switch is located on left side of the JPL Explore base unit.



Connection Diagram

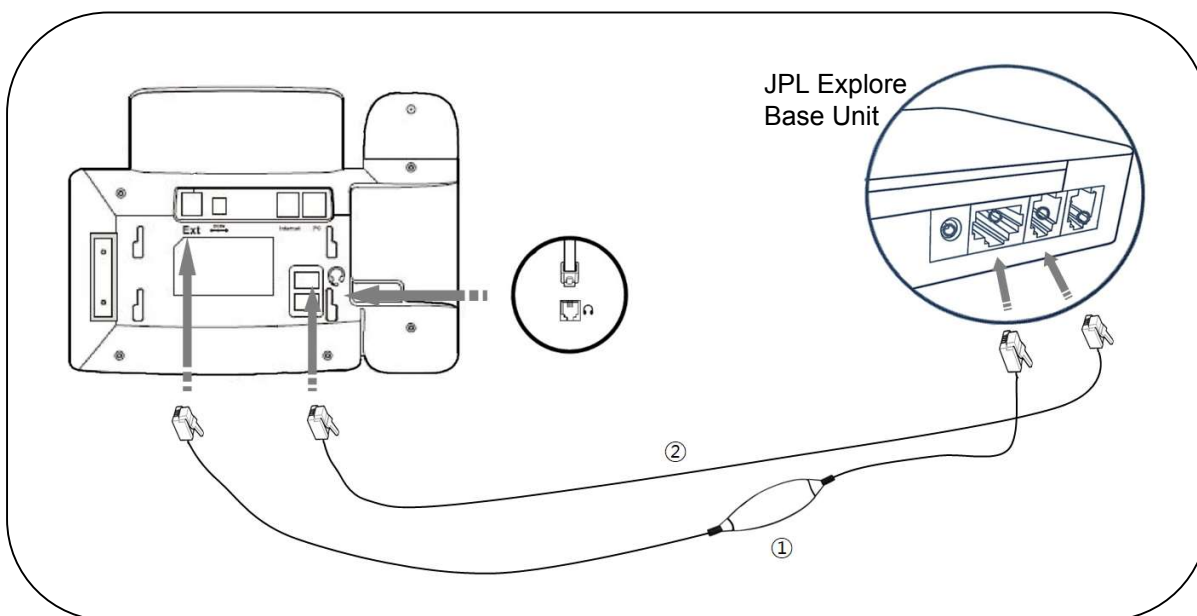

- ① EHS Adapter(EHS-24) : RJ-45 to RJ-12
- ② Telephone cord (RJ-9 to RJ-9) : Cable length 600mm

Toshiba EHS Setup guide

Toshiba	Phones	
	IP5022-SD IP5122-SD	
	IP5122-SDC IP5131-SDL	
	IP5132-SD	
	DP5022-SD DP5022-SDM	
	DP5032-SD DP5122-SD	
	DP530-FSDL DP5130-SDL	
	DP5132-SD	
	IPT2008-SDL, IPT2010-SD, IPT2020-SD	

+

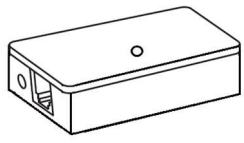

EHS-8

Connection Diagram

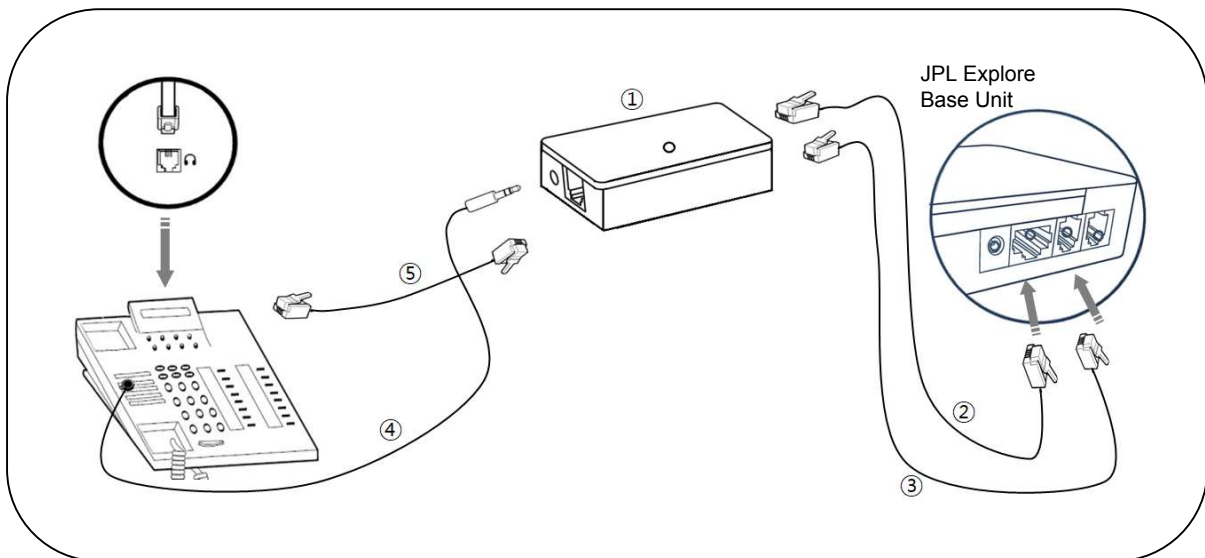

- ① EHS Adapter(EHS-8)
- ② Power cable (RJ-45 to RJ-45) : Cable length : 600mm
- ③ Telephone cord (RJ-9 to RJ-9) : Cable length : 600mm
- ④ External Microphone : For ring detection
- ⑤ Telephone cord (RJ-9 to RJ-9) : Cable length : 300mm

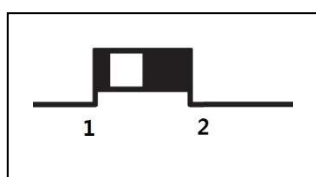

Position of Telephone Compatibility Switch : Set to '1'.
Compatibility switch is located on left side of the JPL Explore base unit.

Yealink EHS Setup guide

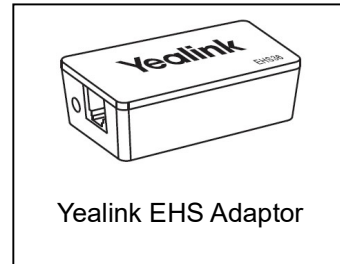
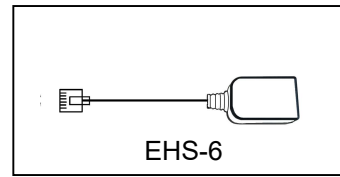

Connection Diagram

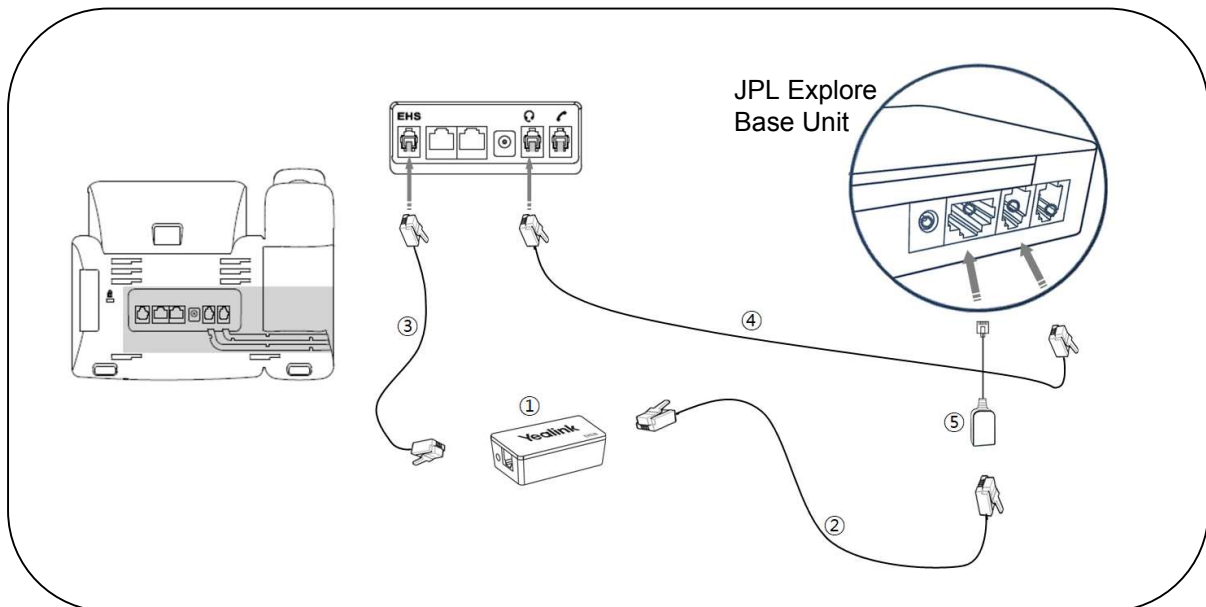

- ① EHS Adapter Yealink (EHS36) : available from Yealink reseller
- ② Cord : available from Yealink reseller
- ③ Cord : available from Yealink reseller
- ④ Cord : available from Yealink reseller
- ⑤ EHS Gender (EHS-6)



Connection Diagram

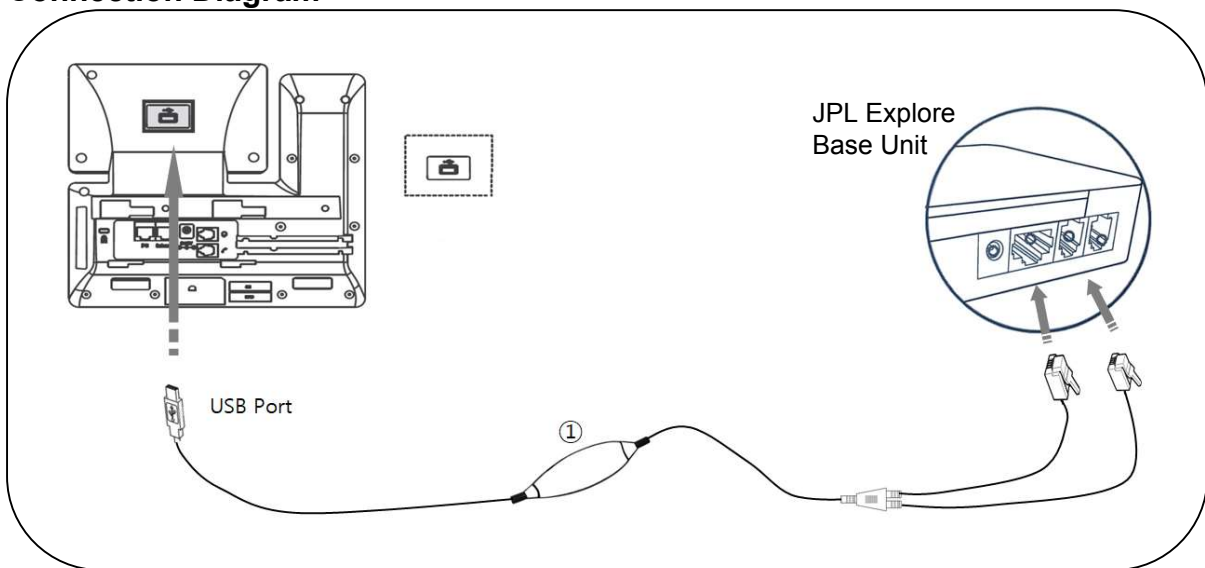

① : EHS Adapter (EHS-28) : RJ-45(8P8c) and RJ-9(4P4C) to USB A-type Plug

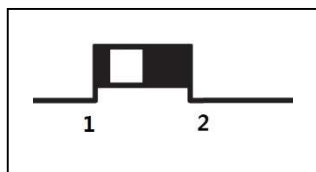

Position of Telephone Compatibility Switch : Set to '1'.
Compatibility switch is located on left side of the JPL Explore base unit.

PC EHS Setup guide

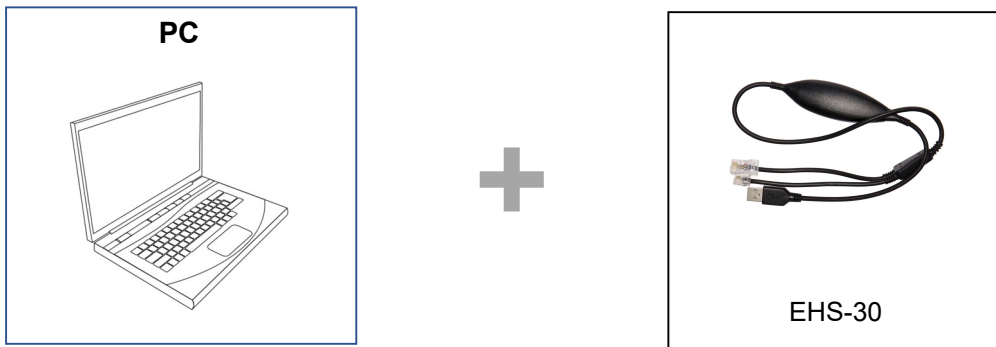

Connection Diagram

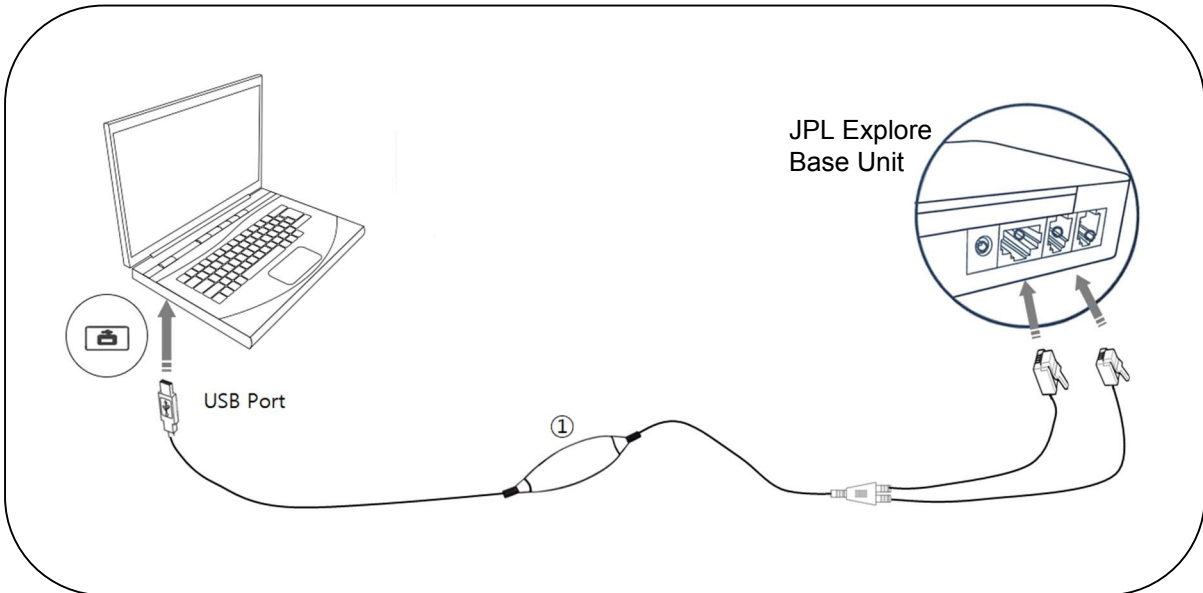

① : EHS Adapter (EHS-30) : RJ-45(8P8c) and RJ-9(4P4C) to USB A-type Plug

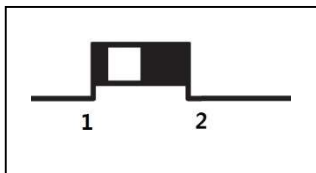

Position of Telephone Compatibility Switch : Set to '1'.
Compatibility switch is located on left side of the JPL Explore base unit.